

Robotics @ Zhenghua

- What is Robotics?
- What is Mindstorms/EV3
- 2-Wheel Robots
- Robot Educator Build



A POSTERIORI

Play · Experience · Learn

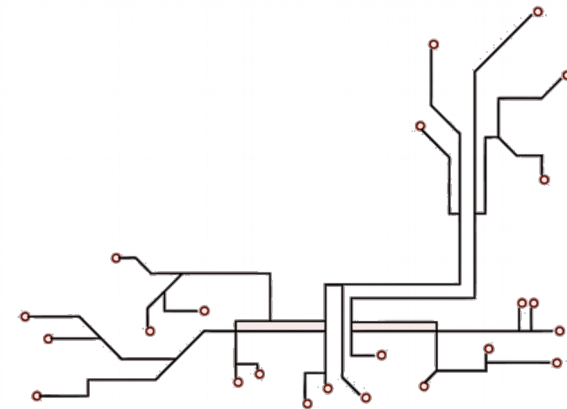

What is Robotics?

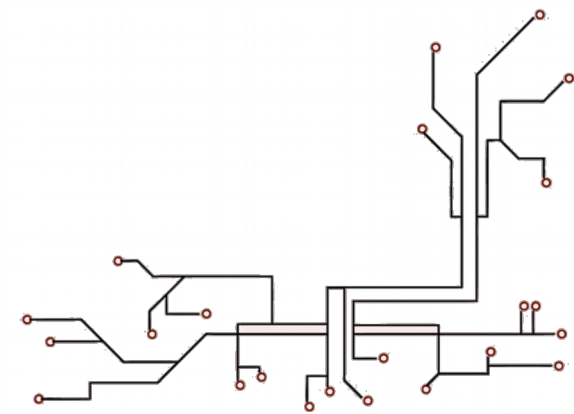
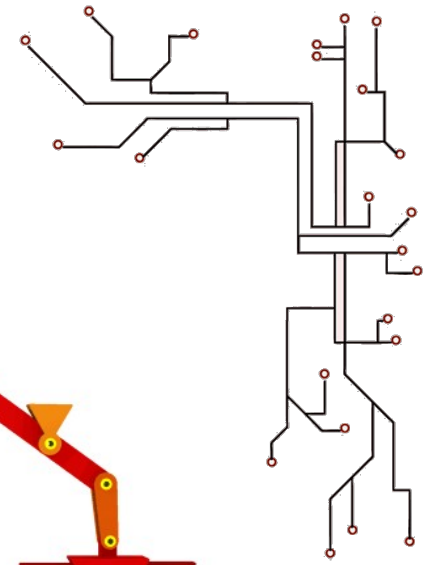
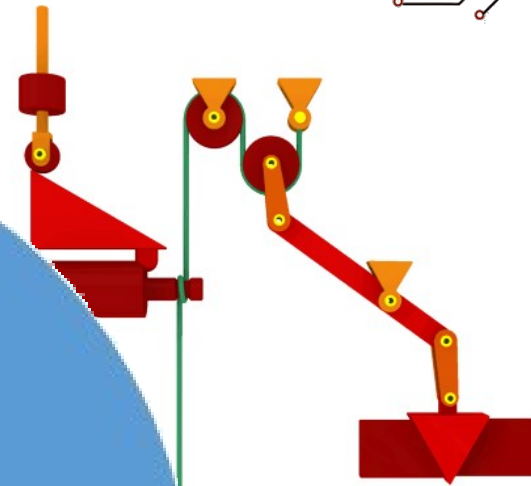
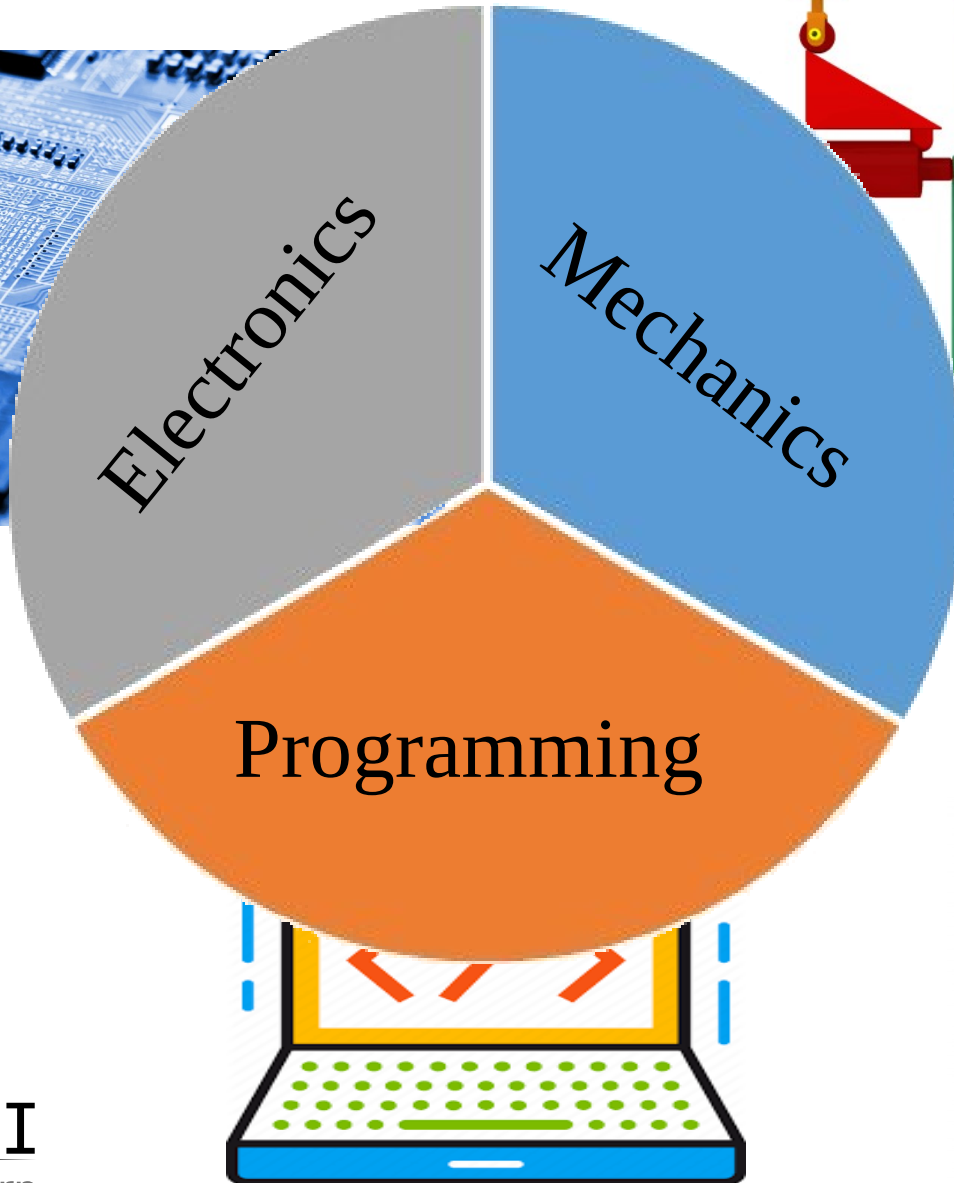
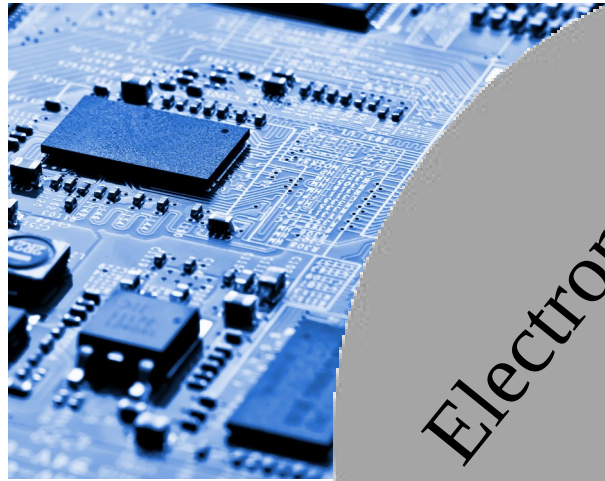

What is a Robot?

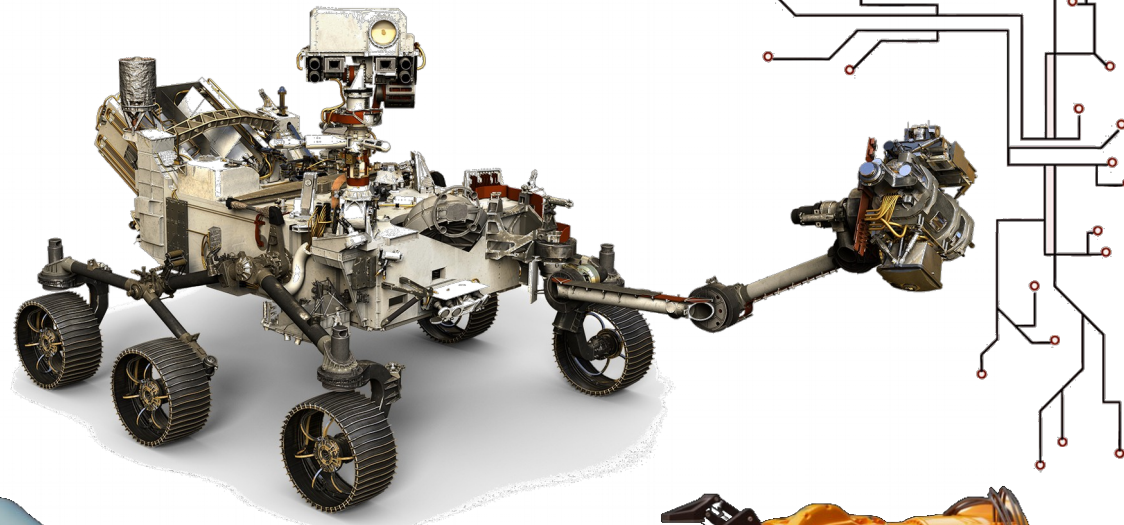
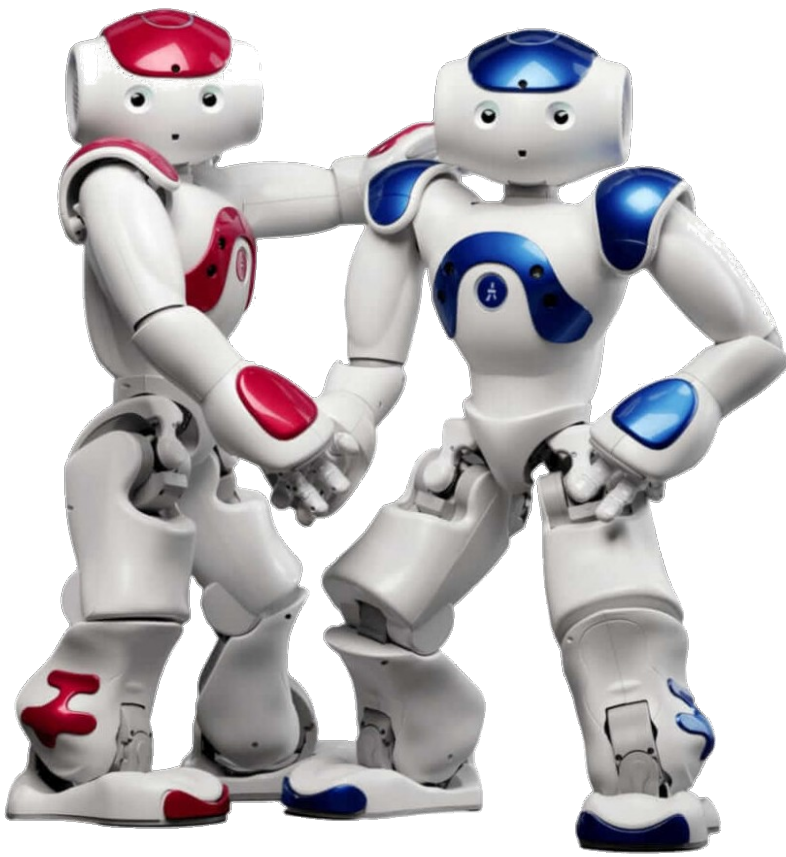

A POSTERIORI
Play · Experience · Learn

What is a Robot?

Almost anything automated...

But, physical robots usually have these:

- *Computer Brain*
- *Body / Frame*
- *Motors*
- *Sensors*
- *Wires*

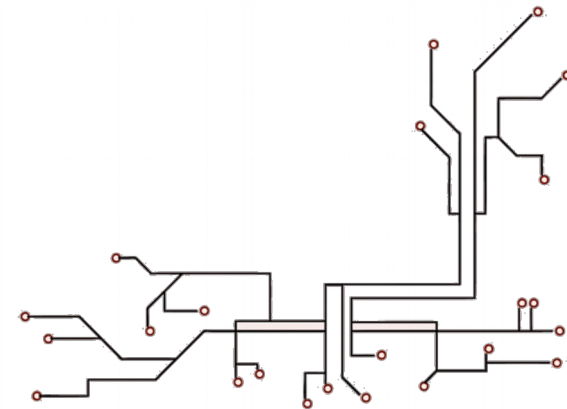
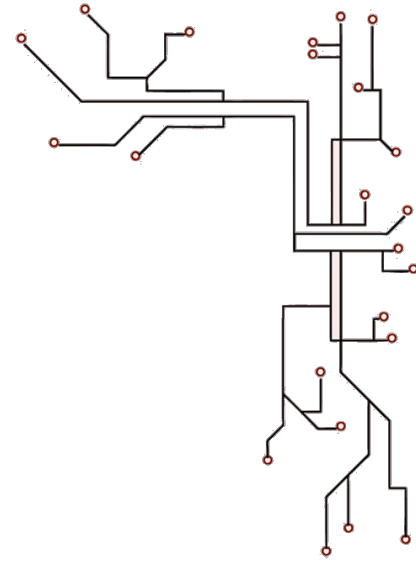

A POSTERIORI

Play · Experience · Learn

What is Mindstorms/EV3?

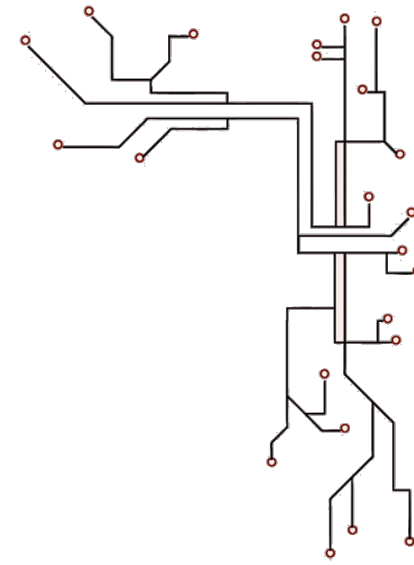
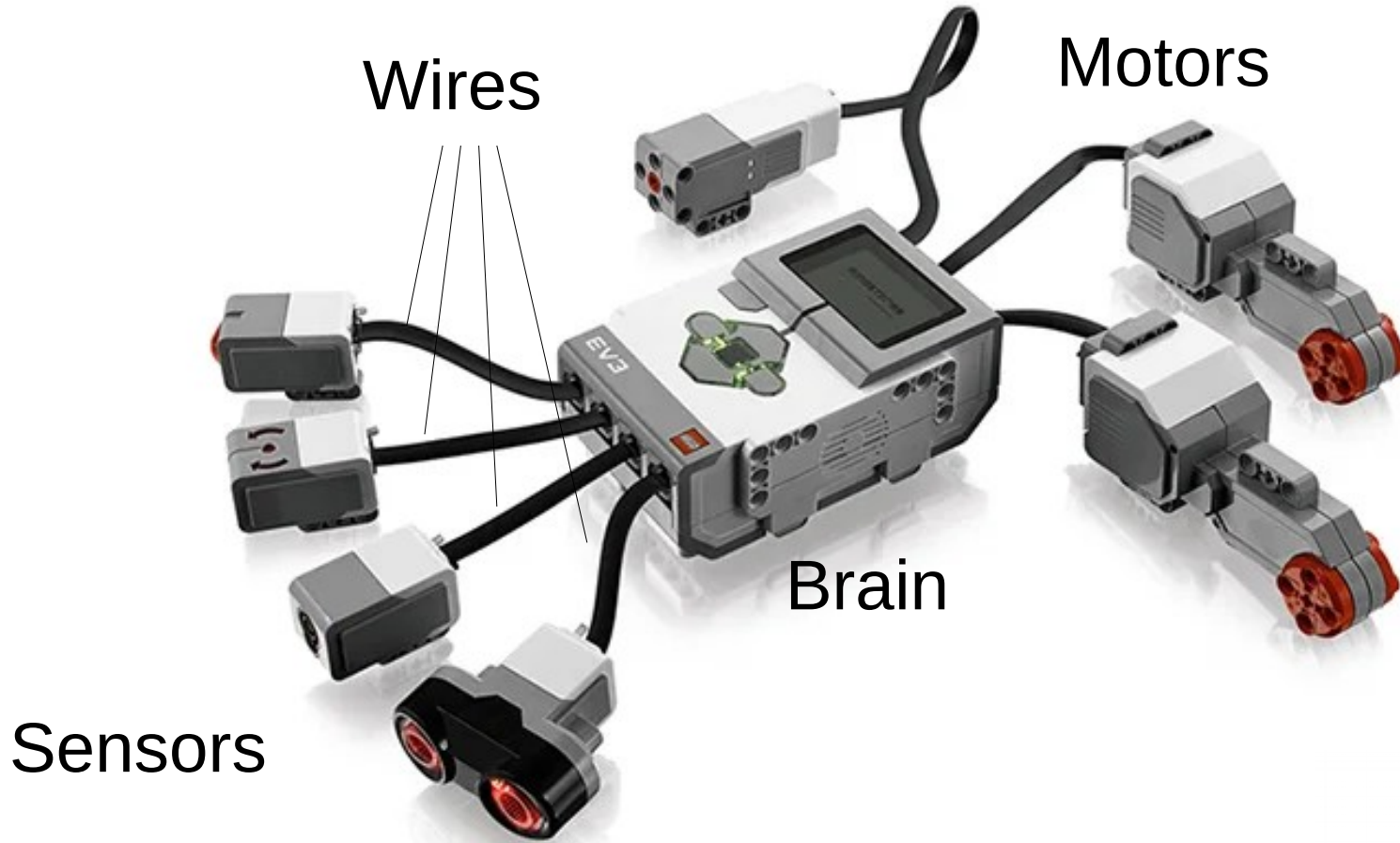

A POSTERIORI
Play · Experience · Learn

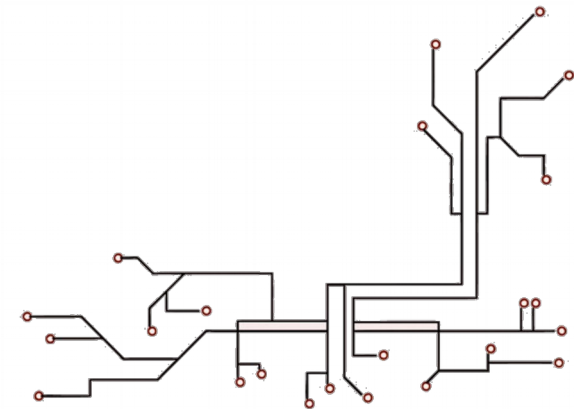

EV3 Programming

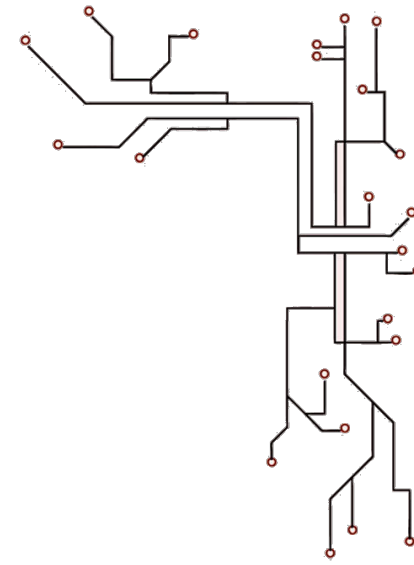
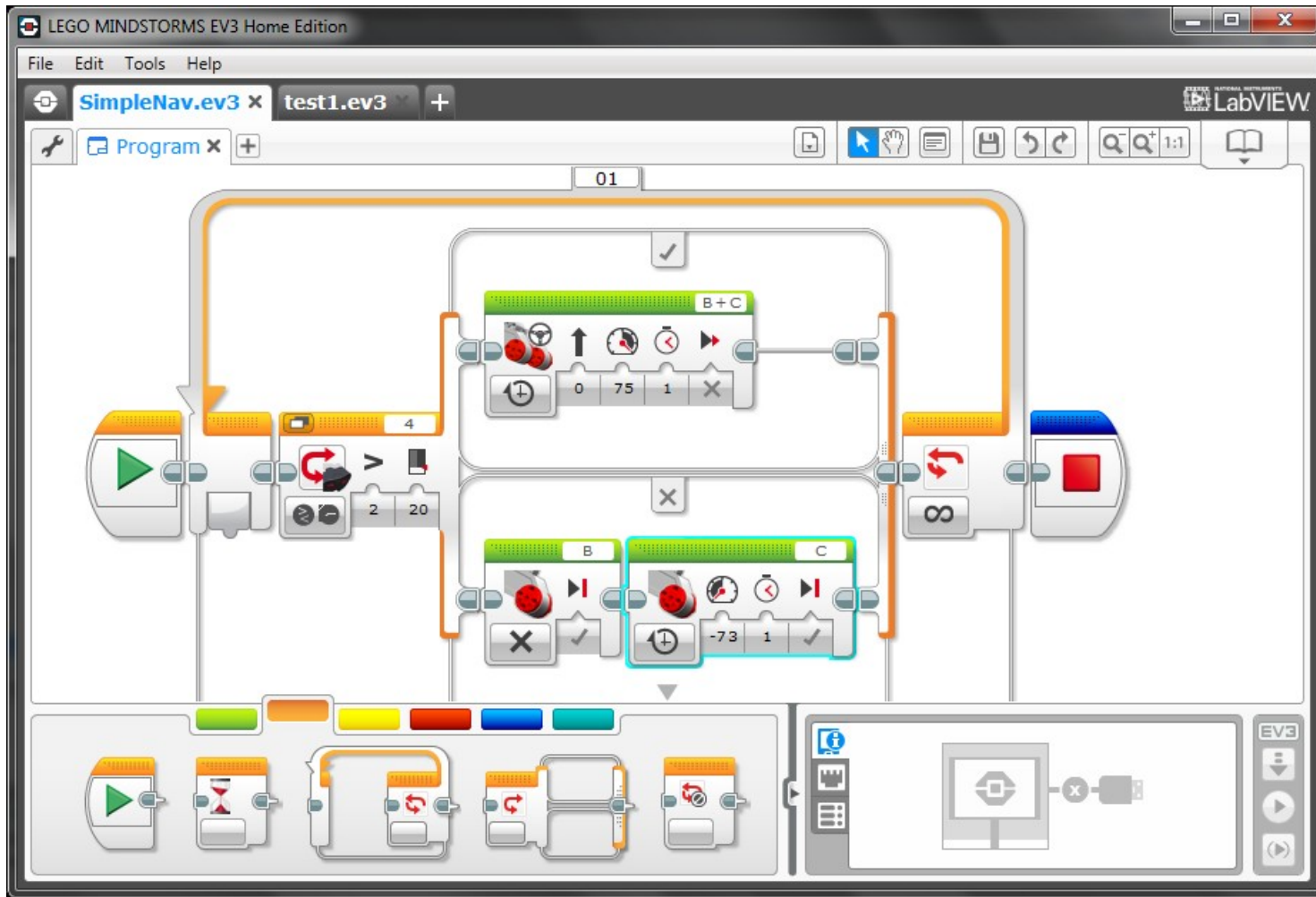

Block Programming

- Easy to learn
- Not professional...

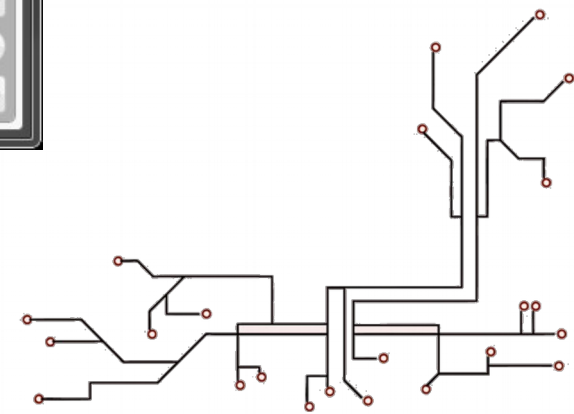

A POSTERIORI

Play · Experience · Learn

EV3 Robot Educator

2-Wheel Base

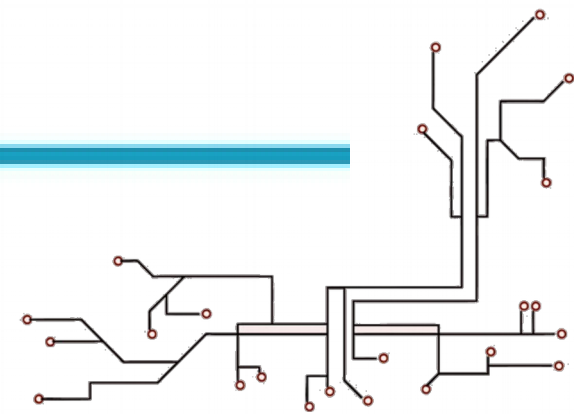
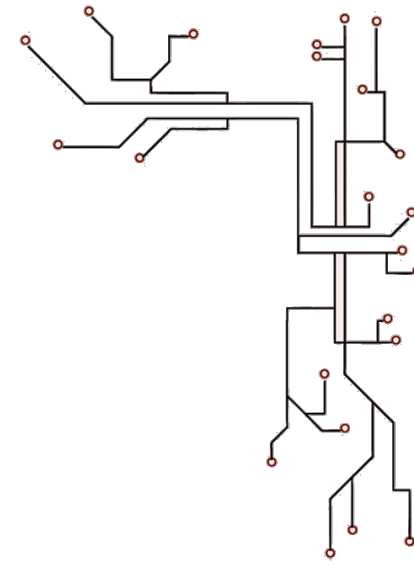
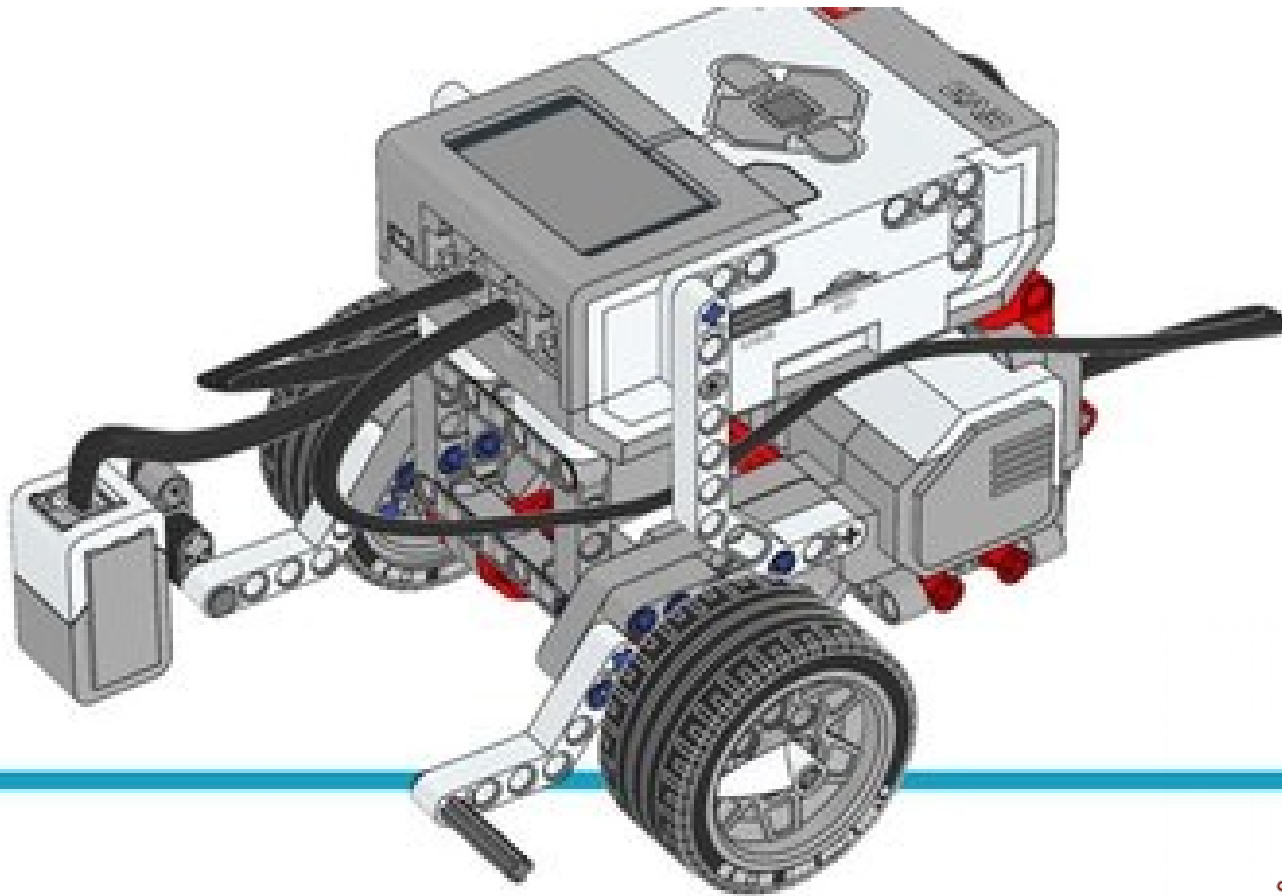

2-Wheel Differential Drive

Forward

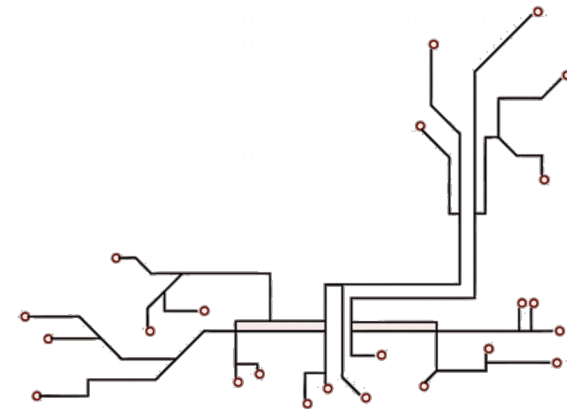
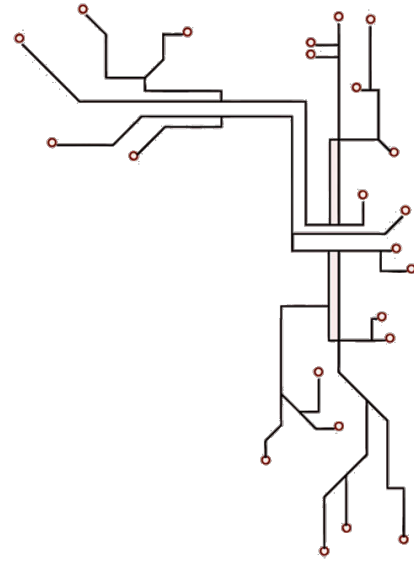
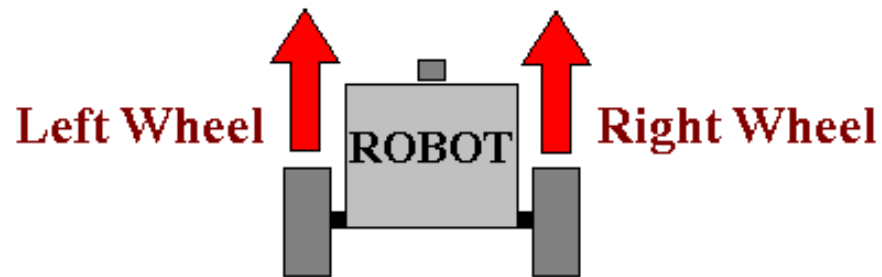

2-Wheel Differential Drive

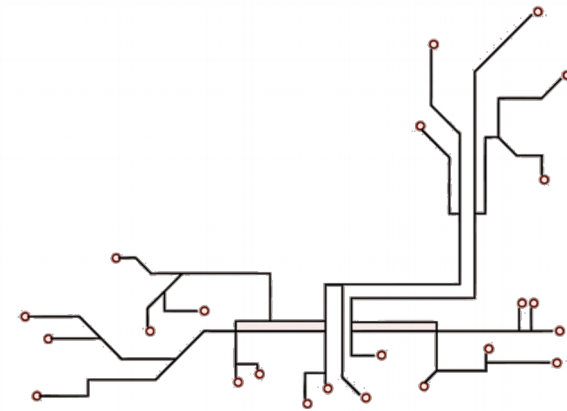
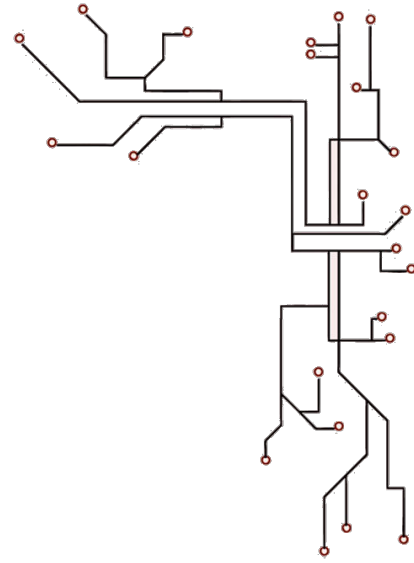
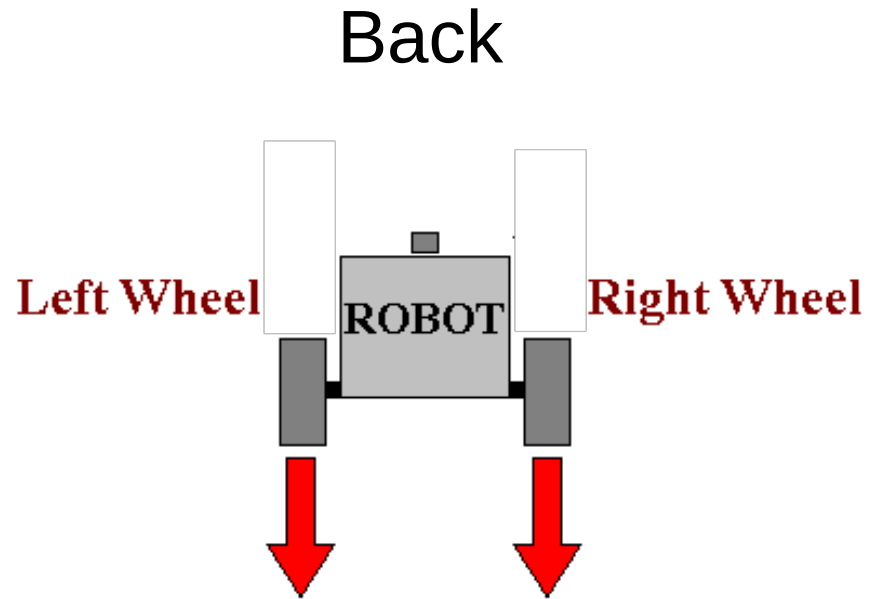

2-Wheel Differential Drive

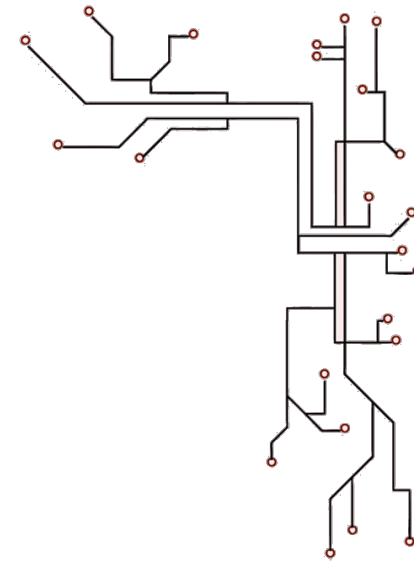

Left Turn

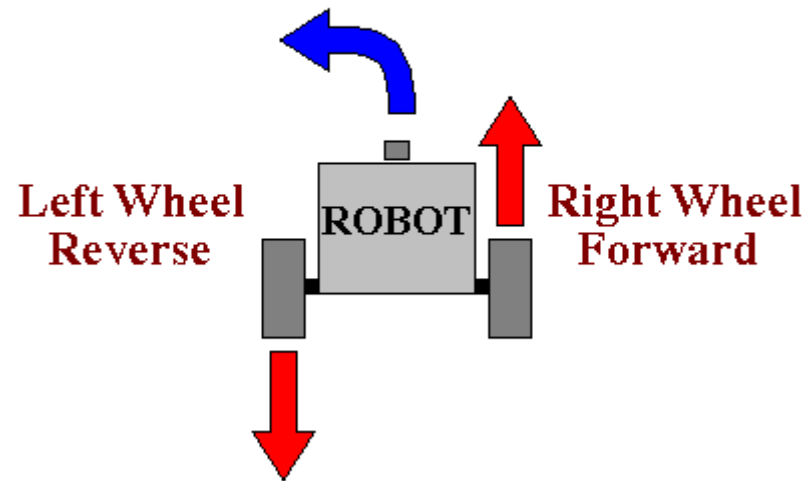

A POSTERIORI

Play · Experience · Learn

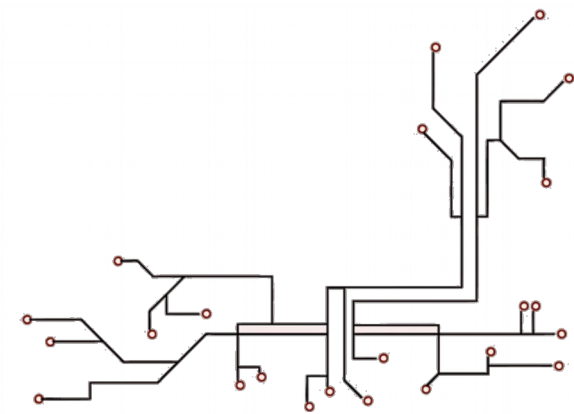

2-Wheel Differential Drive

Right Turn

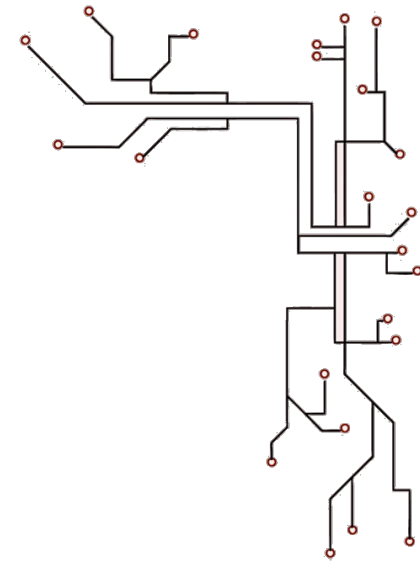
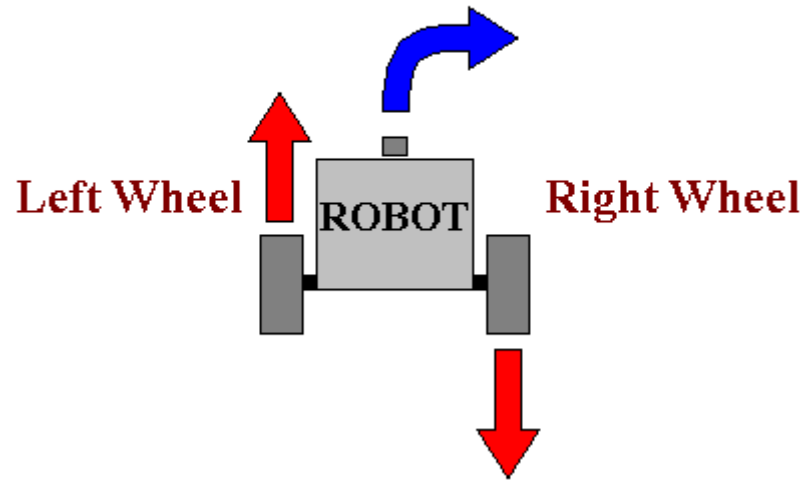

A POSTERIORI

Play · Experience · Learn

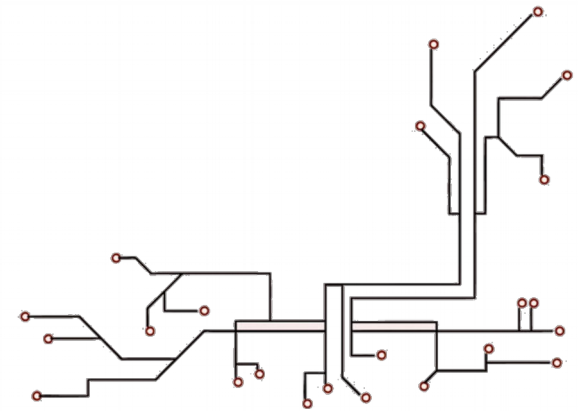

EV3 Robot Educator

Let's Build!!!

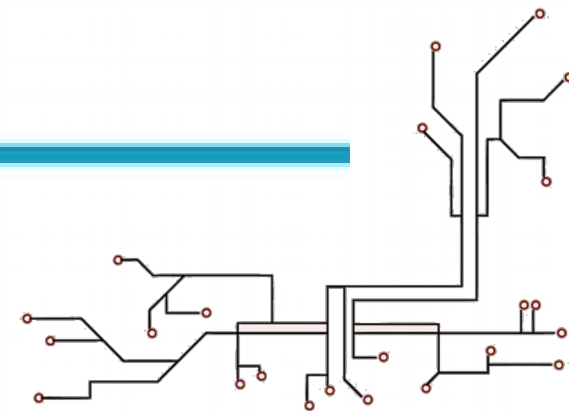
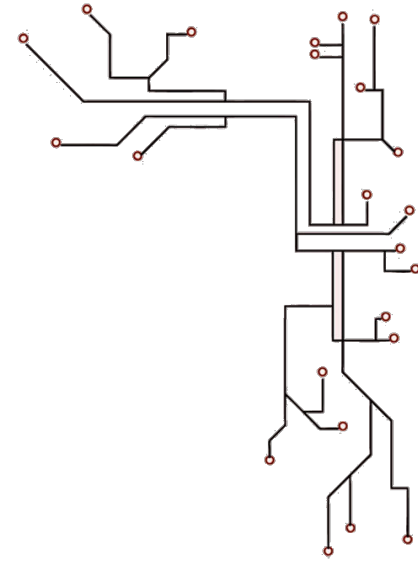
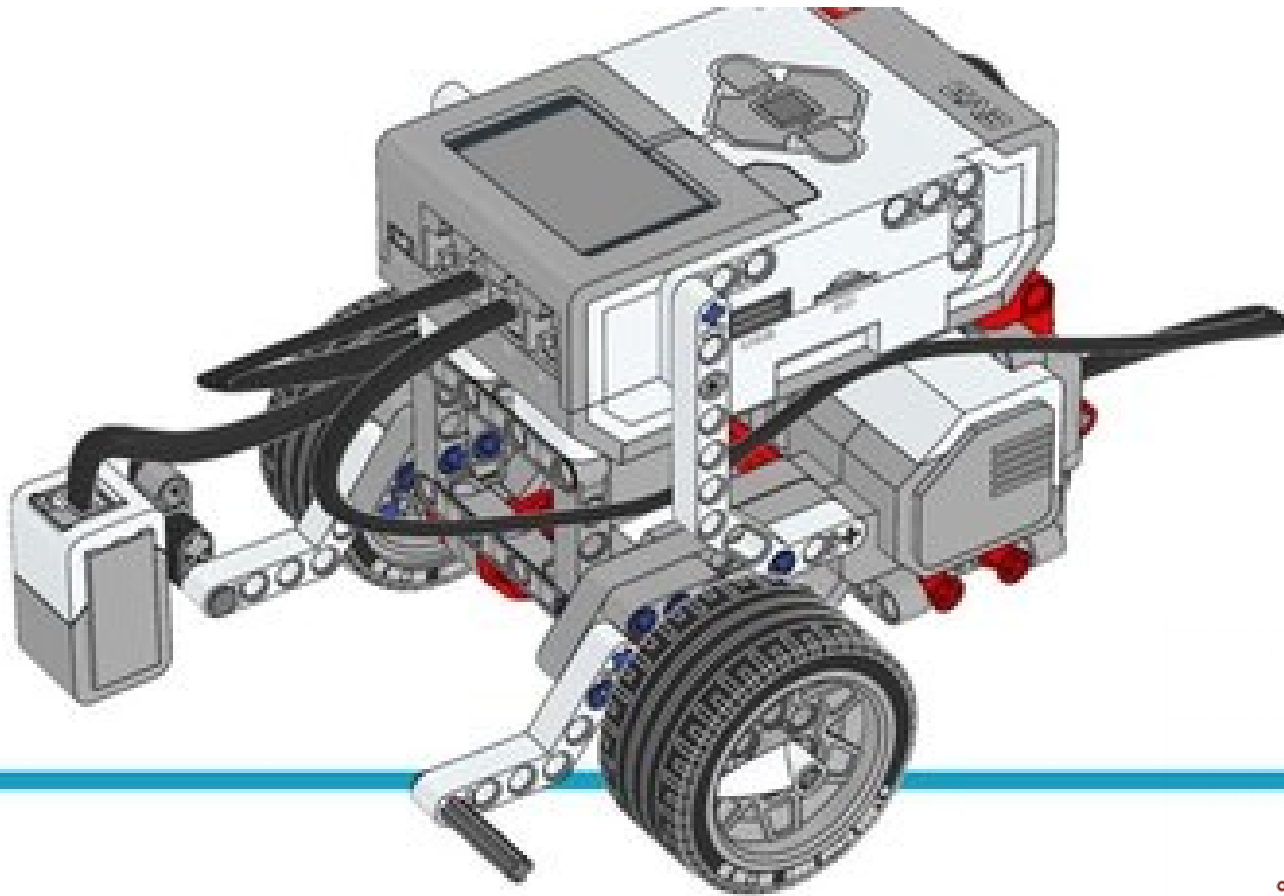

A POSTERIORI
Play · Experience · Learn

EV3 Robot Educator

Then Program...

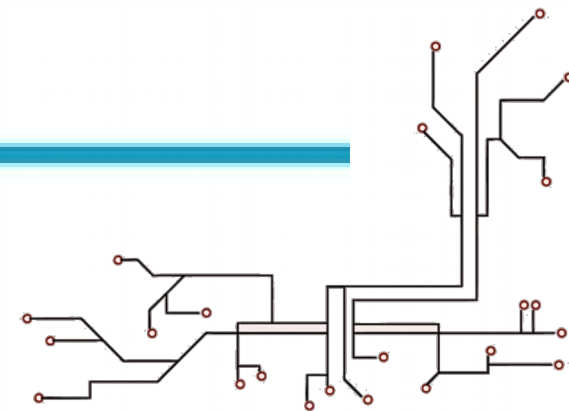
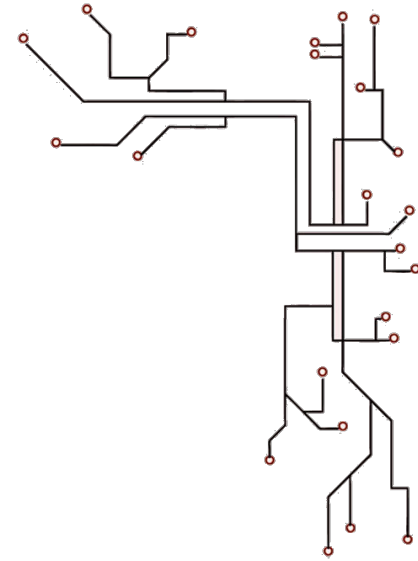
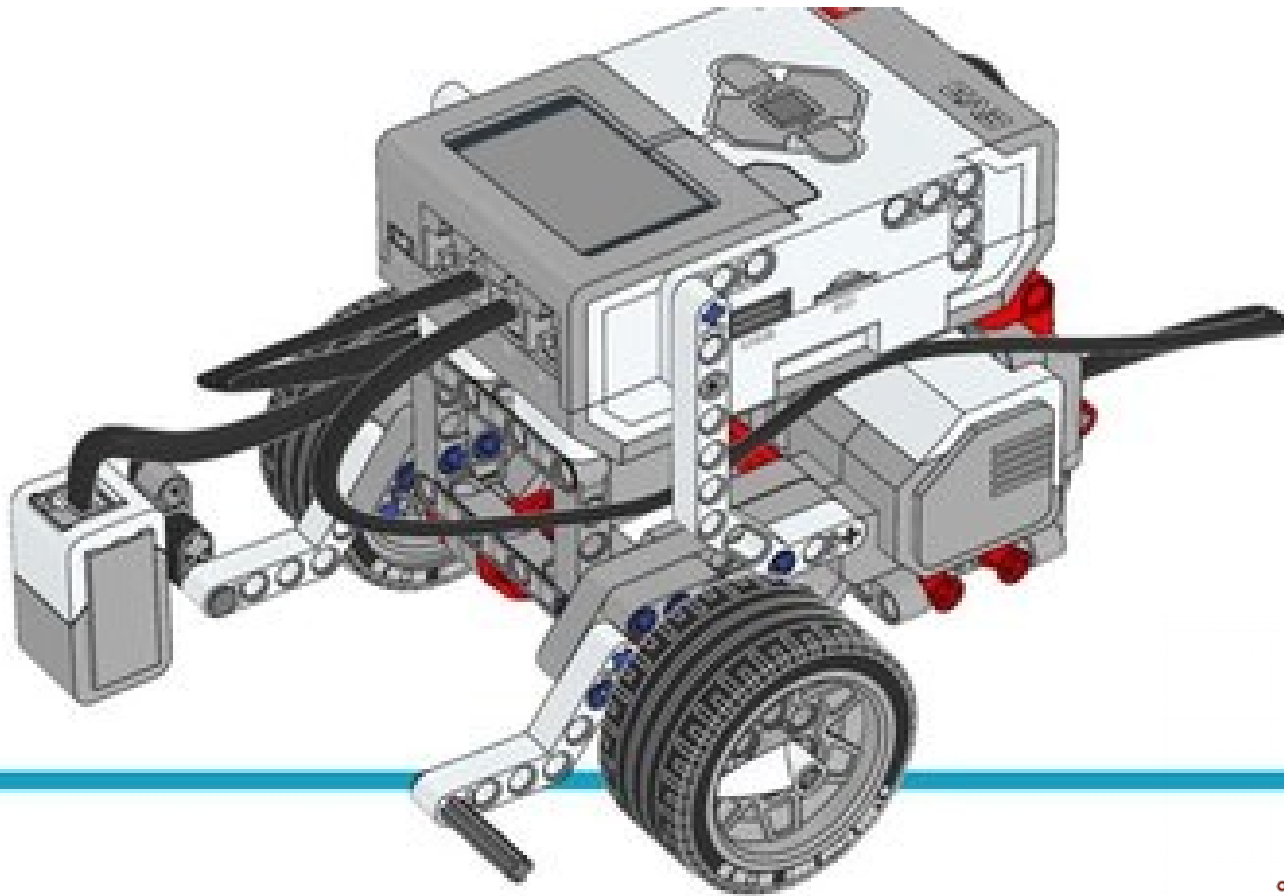

A POSTERIORI
Play · Experience · Learn