

CoSpace – State Machine

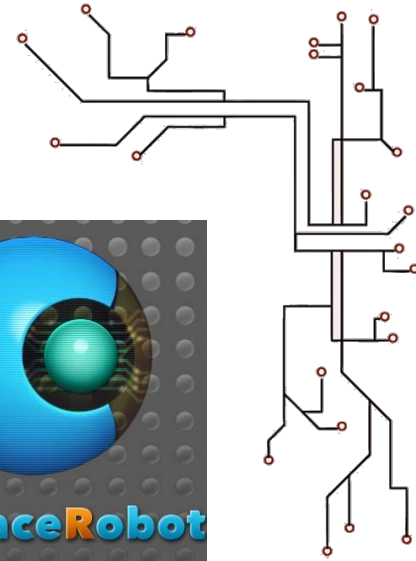
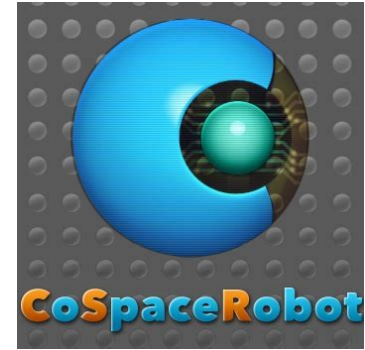

- What is a State Machine?
- Strategy & States In CoSpace Rescue
- CoSpace Rescue State Machine Examples

A POSTERIORI

Play · Experience · Learn

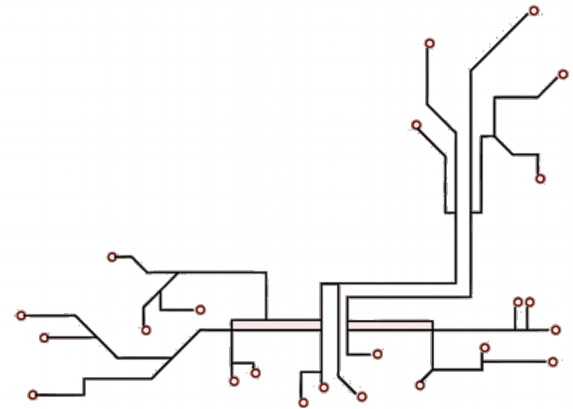

CoSpace – State Machine

- Finite State Machine
- States & Transitions
- Conditions & Actions

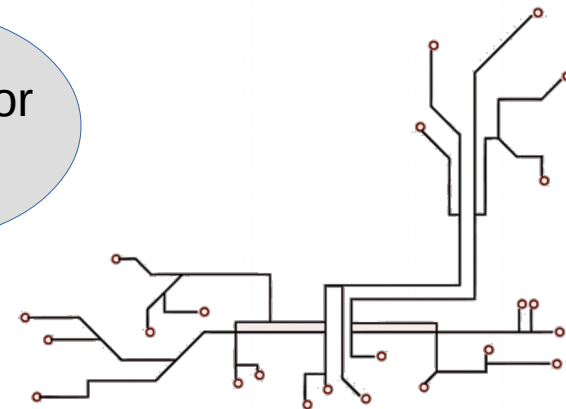
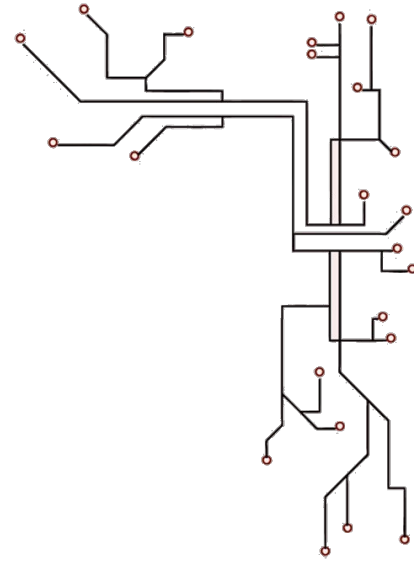
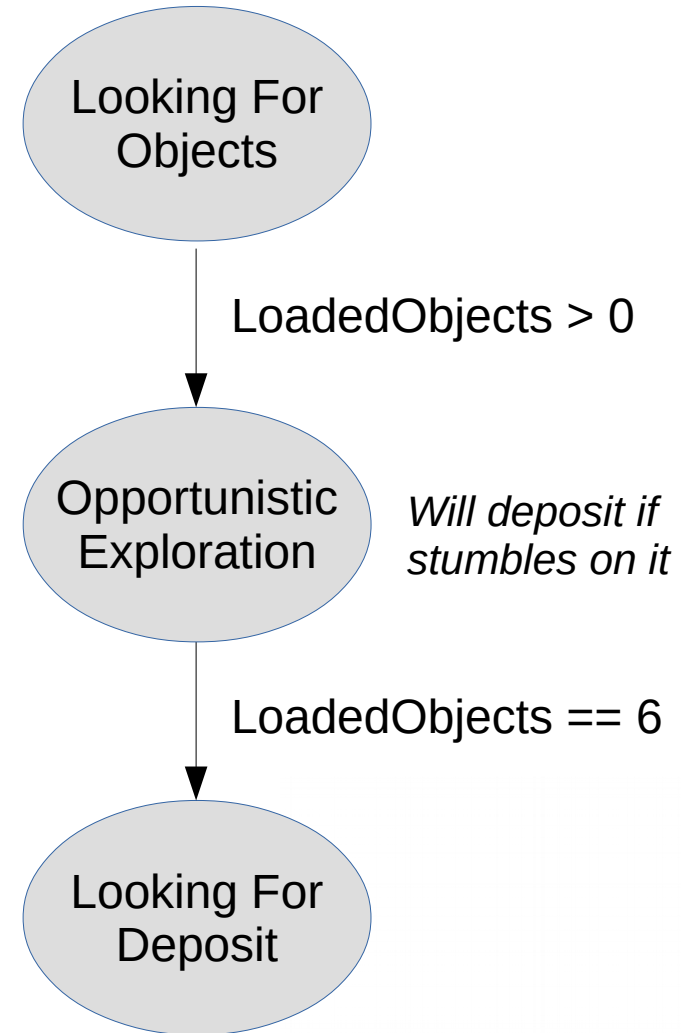

A POSTERIORI

Play · Experience · Learn

CoSpace – Strategy & States

- RRGGBB

- Keep track of objects
- Change State as you fill up

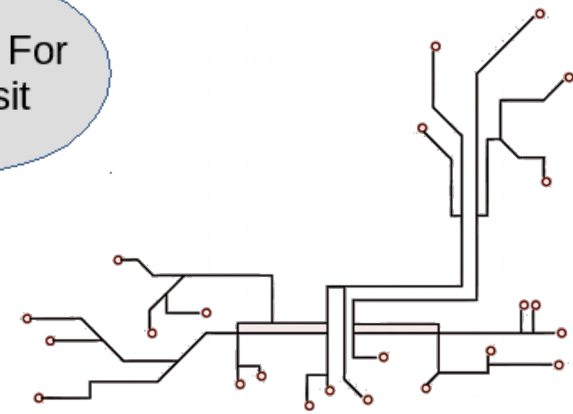
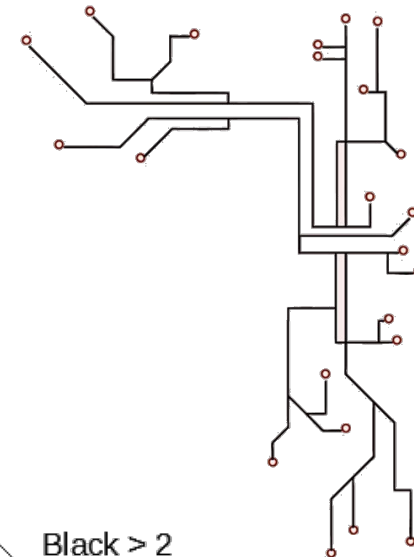
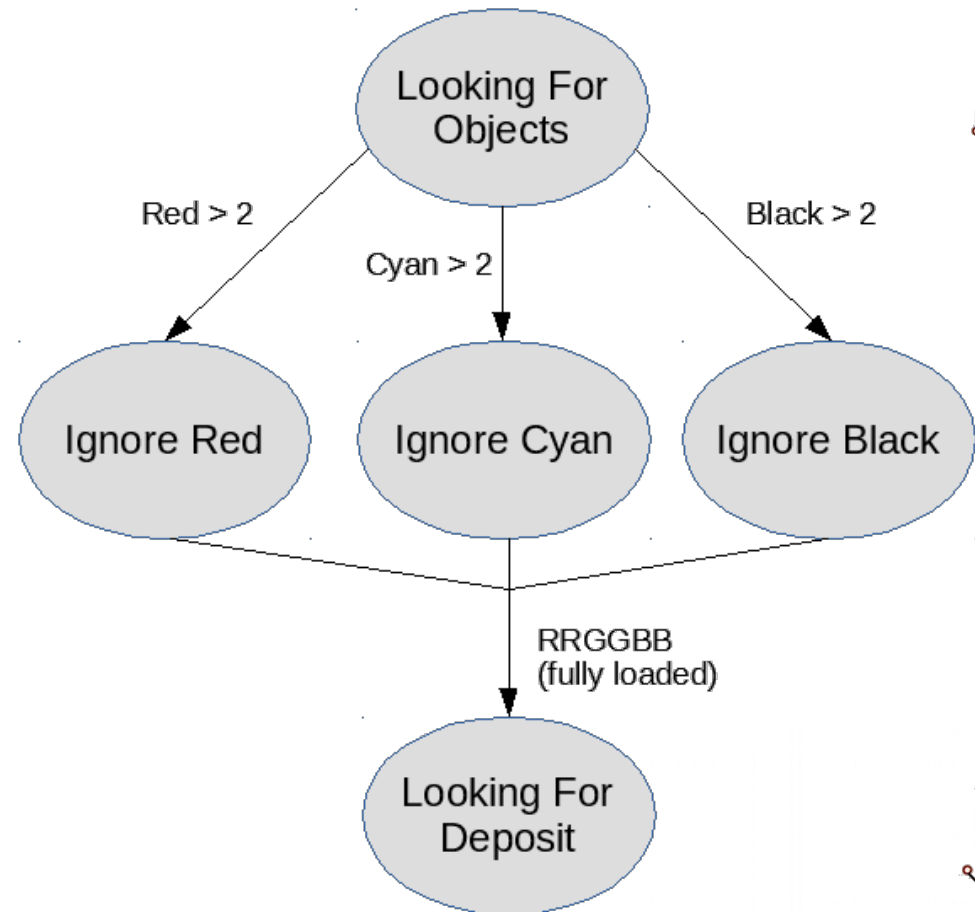

A POSTERIORI

Play · Experience · Learn

CoSpace – State Machine

- High-Point areas

- Explore within Blue surface
- New State has condition
 - treat white as a wall

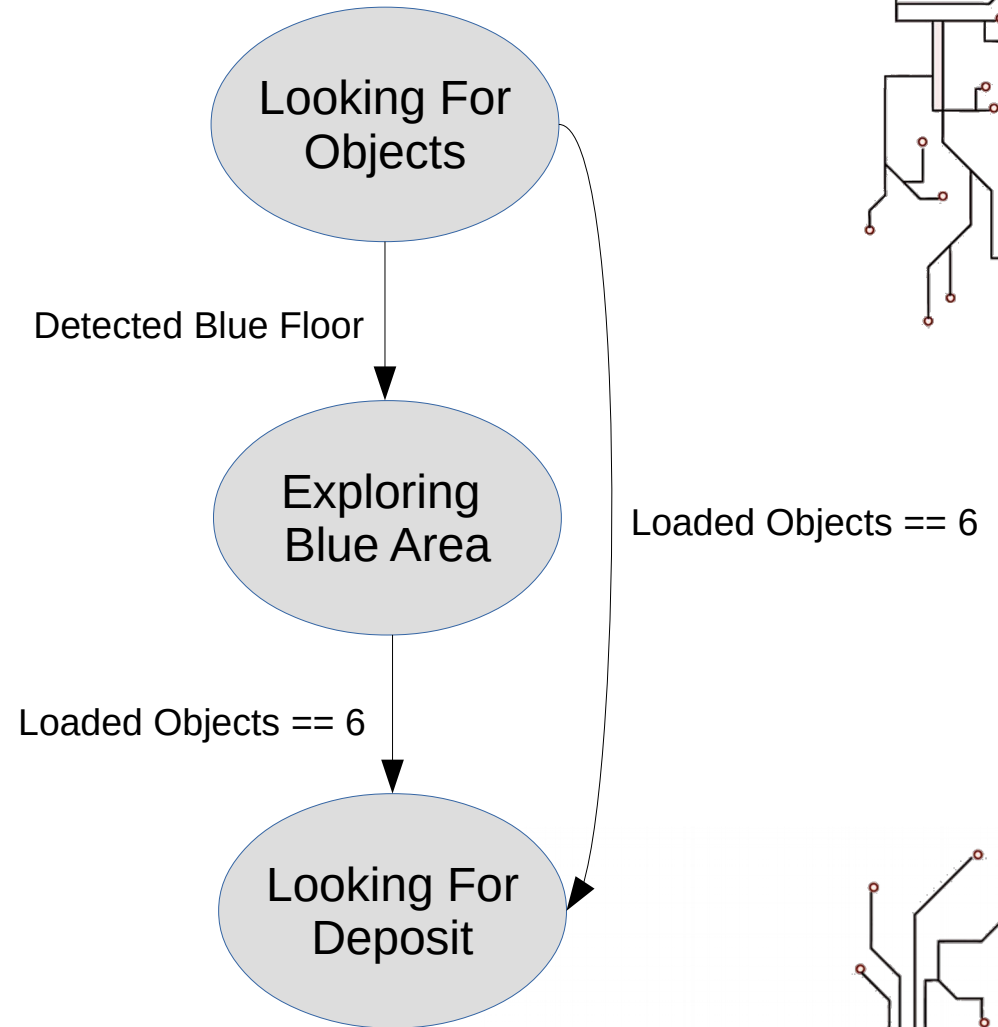

A POSTERIORI

Play · Experience · Learn