

# Intro to LEGO Robotics

- What is Robotics?
- What is Mindstorms/EV3
- 2-Wheel Robots
- Robot Educator Build

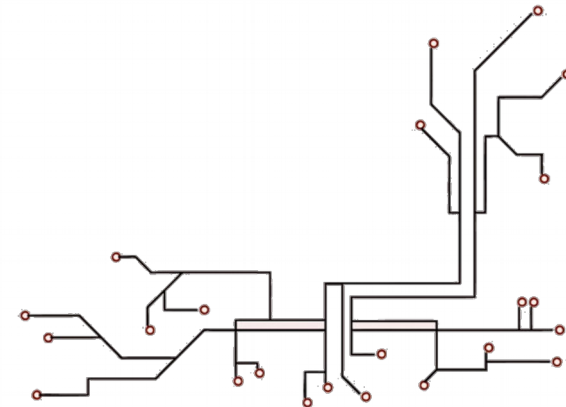
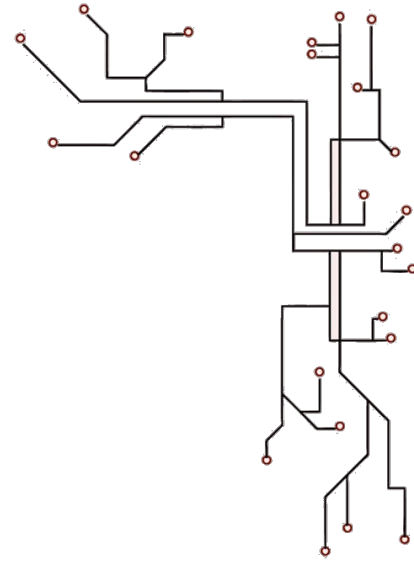

**A POSTERIORI**

Play · Experience · Learn

# What is Robotics?

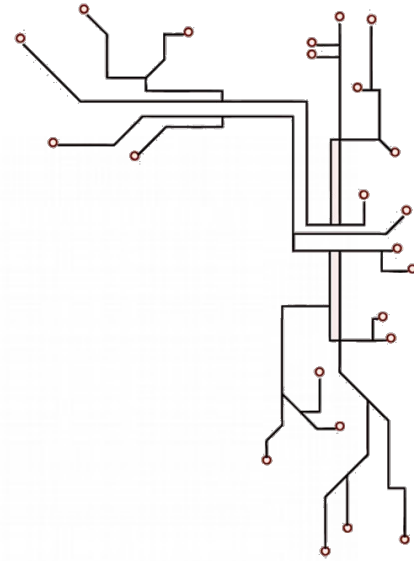
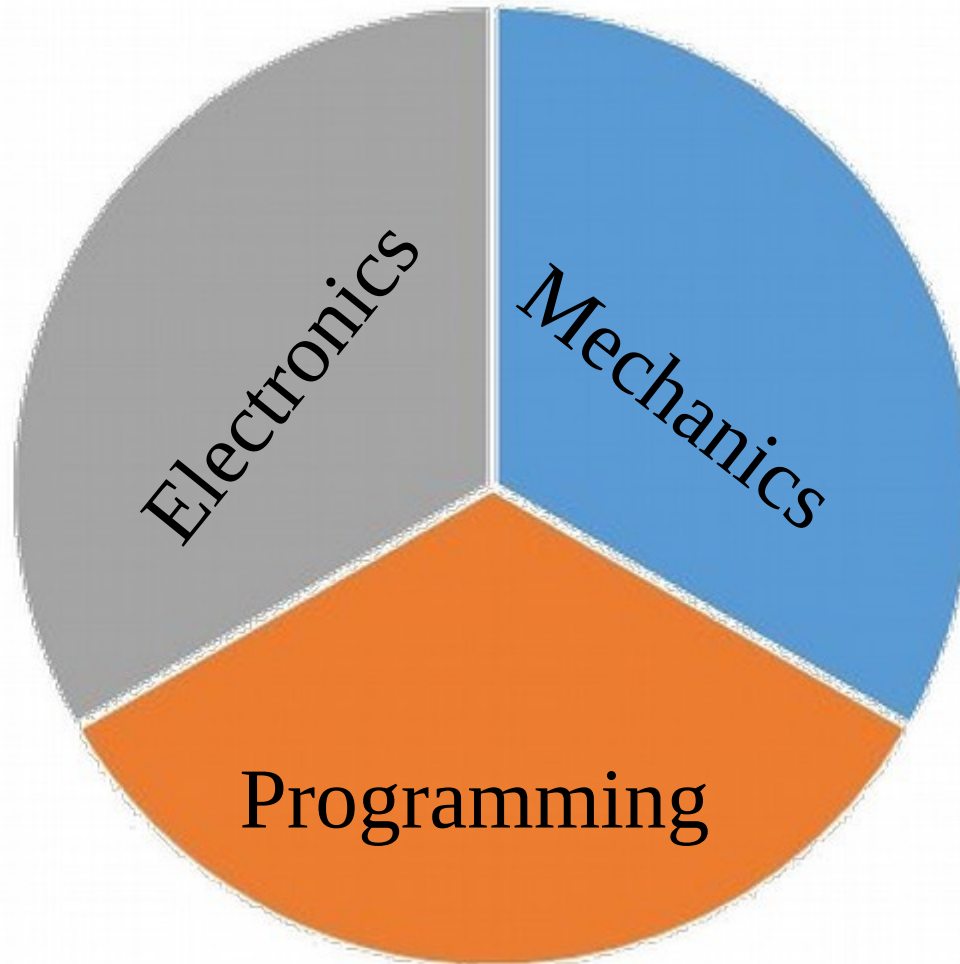

**A POSTERIORI**  
Play · Experience · Learn

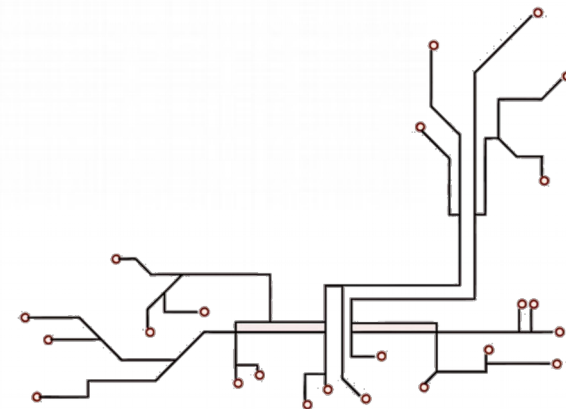

# What is a Robot?

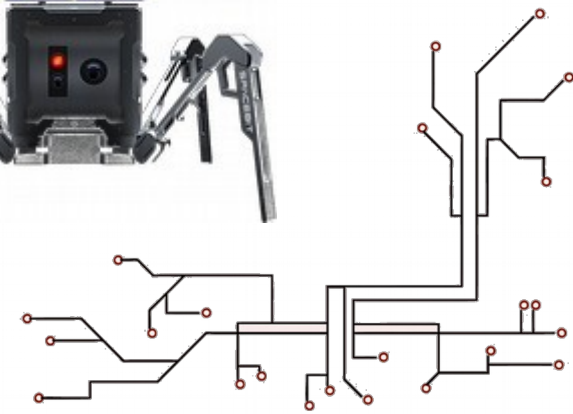
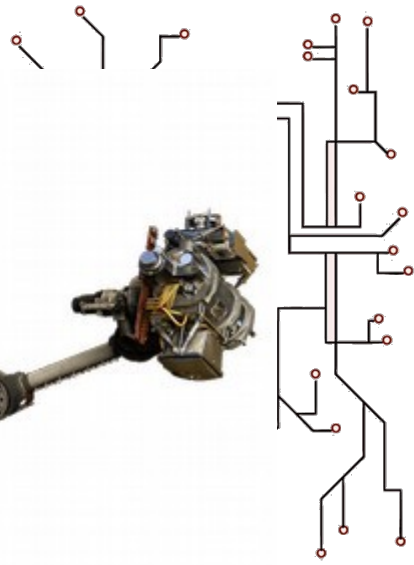
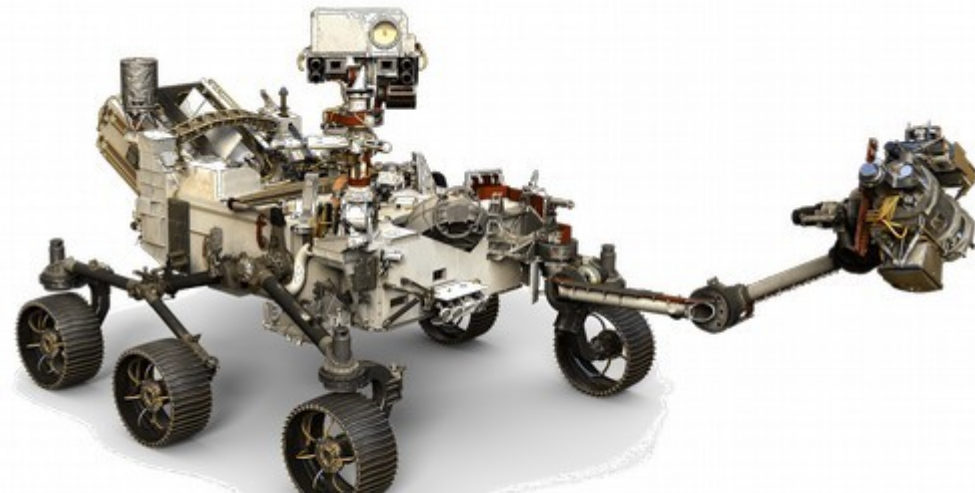

**A POSTERIORI**  
Play · Experience · Learn

# What is a Robot?

**Almost anything automated...**

But, physical robots usually have these:

- *Computer Brain*
- *Body / Frame*
- *Motors*
- *Sensors*
- *Wires*

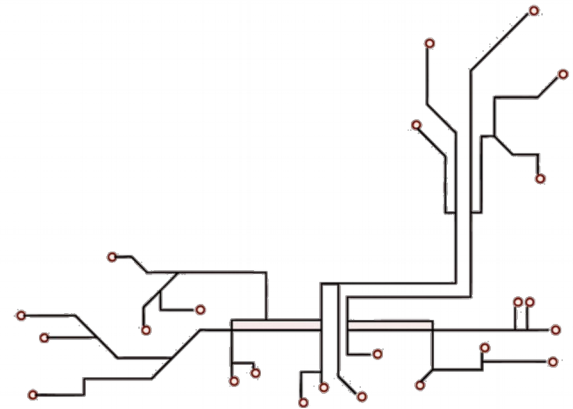
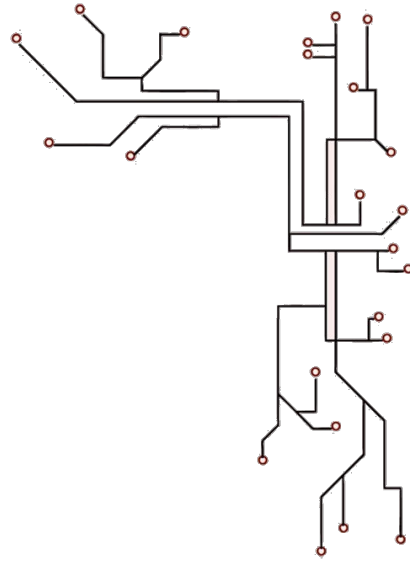

# What is Mindstorms/EV3?

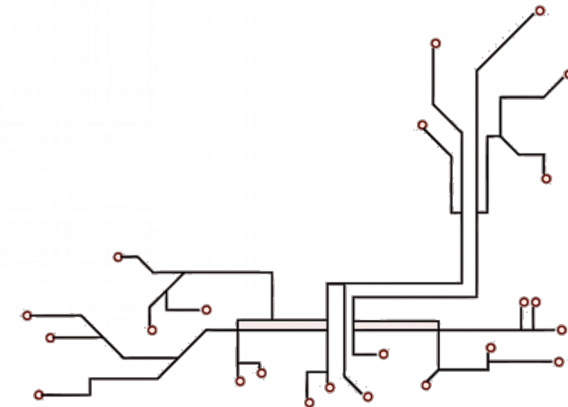
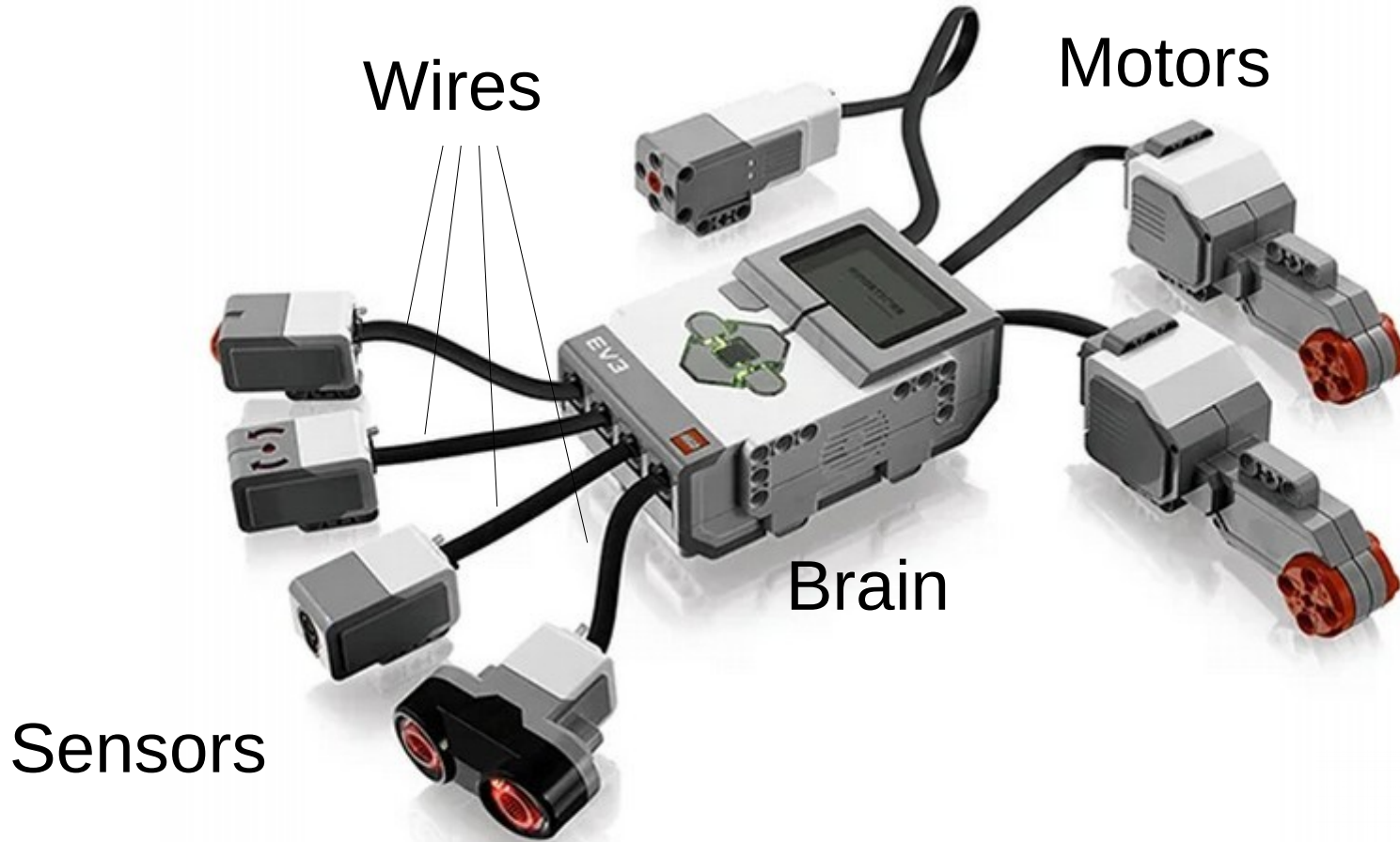
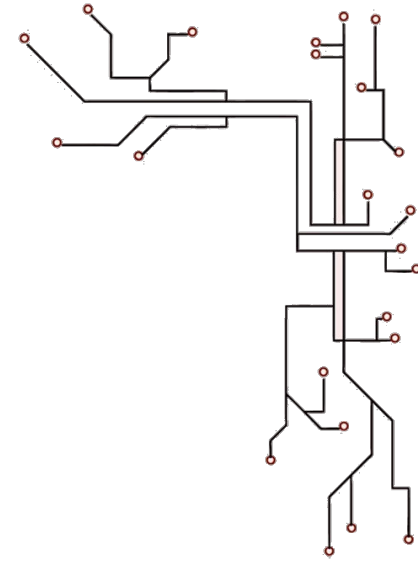

**A POSTERIORI**

Play · Experience · Learn

# EV3 Programming

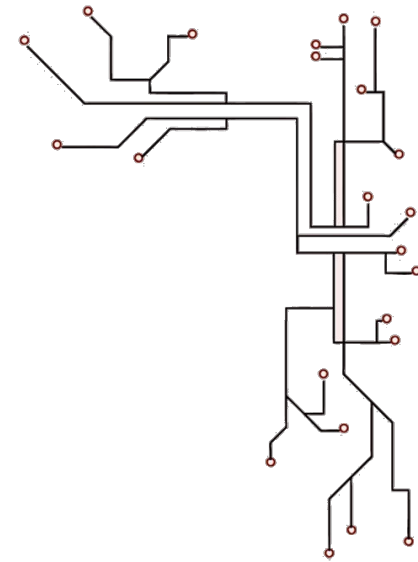
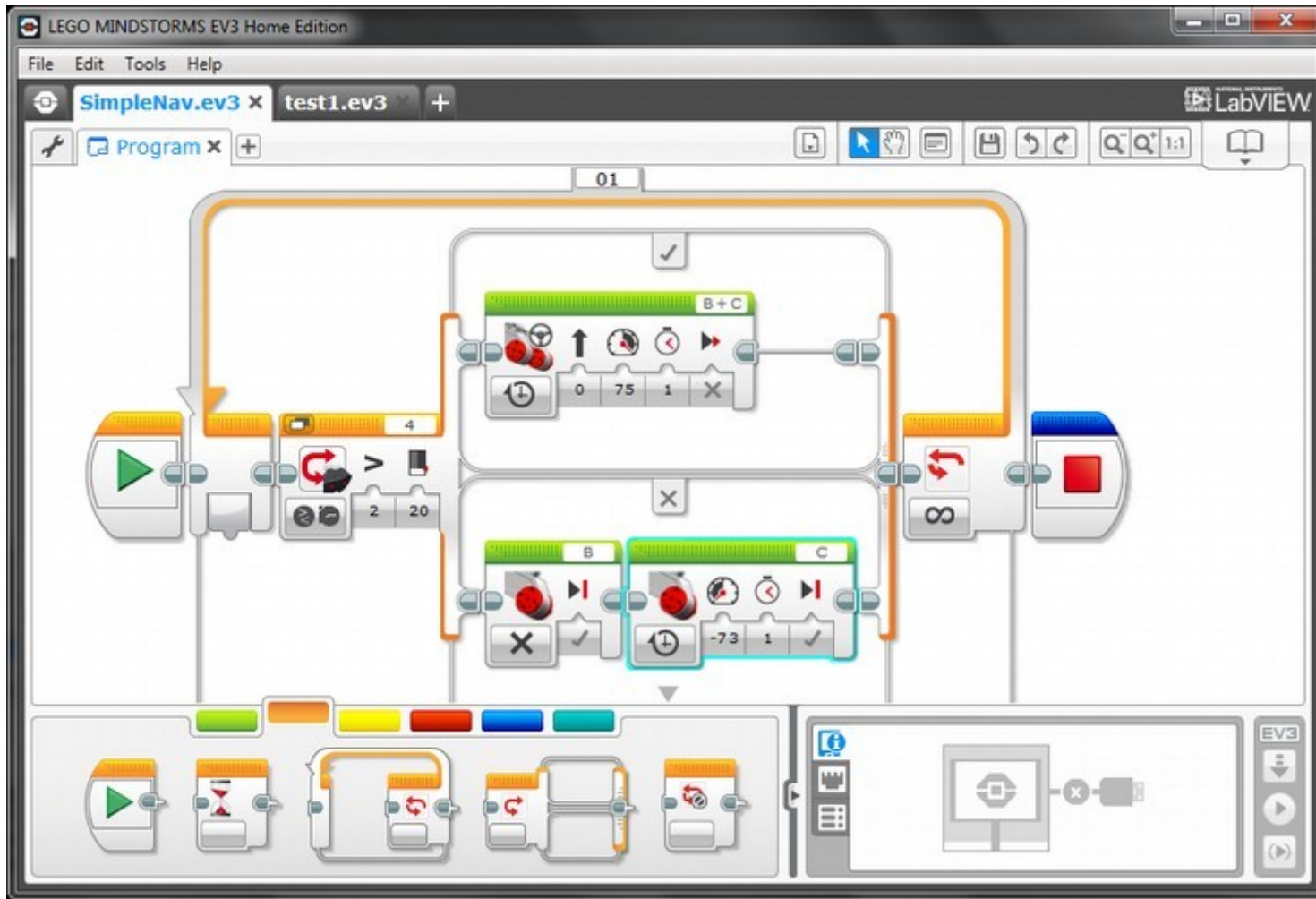

## Block Programming

- Easy to learn
- Not professional...

**A POSTERIORI**

Play · Experience · Learn

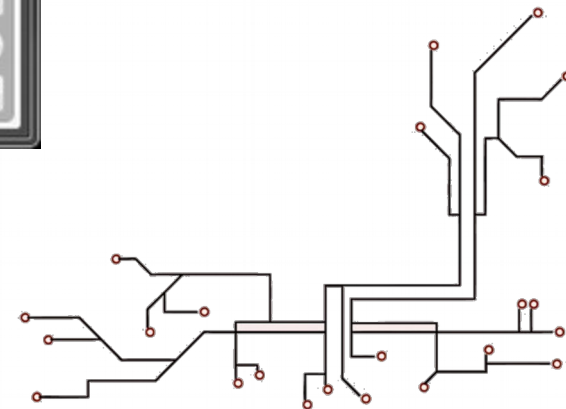

# EV3 Robot Educator

## 2-Wheel Base

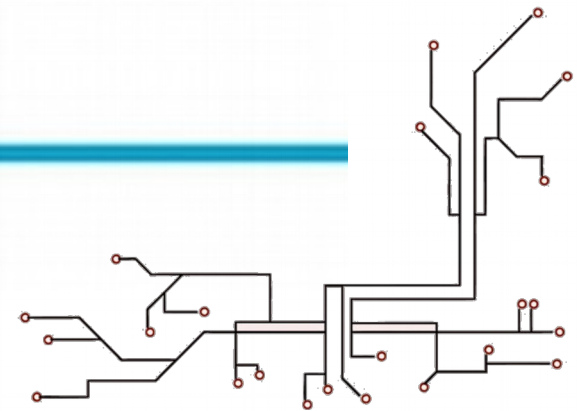
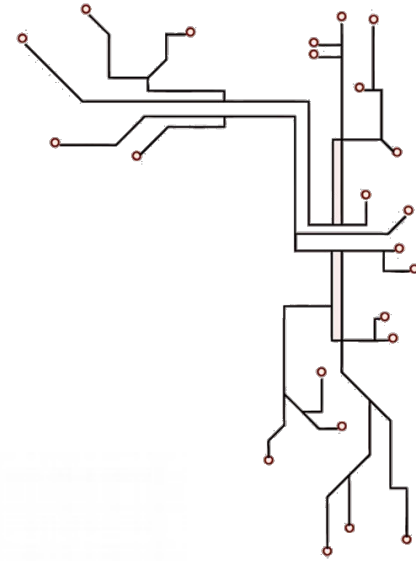
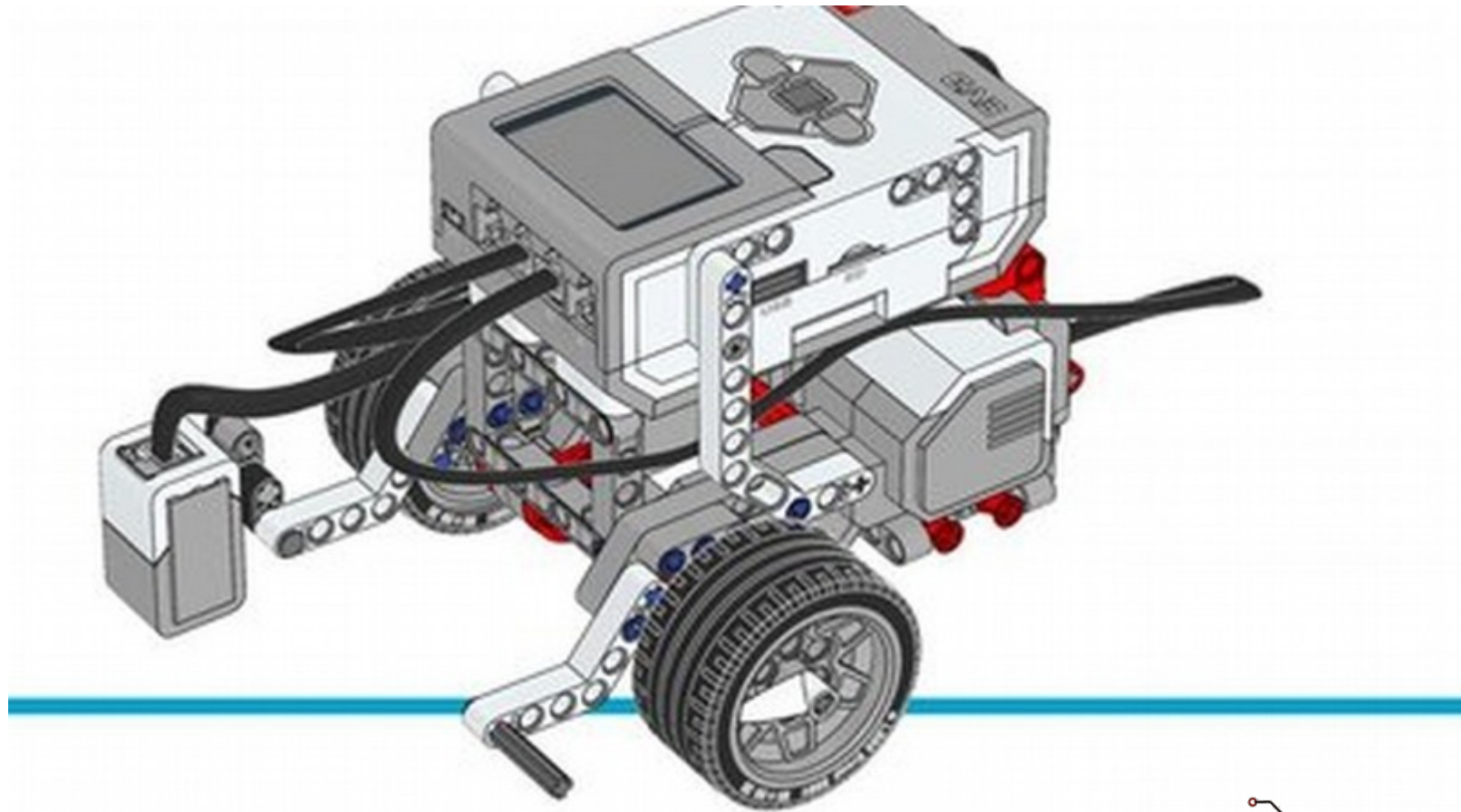

# 2-Wheel Differential Drive

Forward

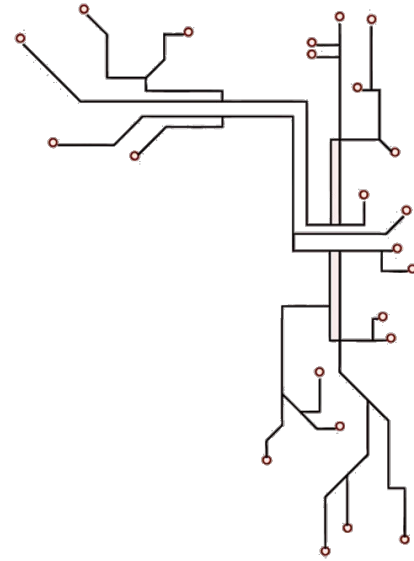
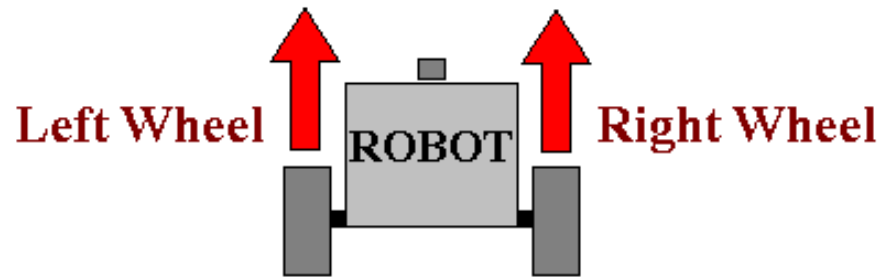

**A POSTERIORI**

Play · Experience · Learn

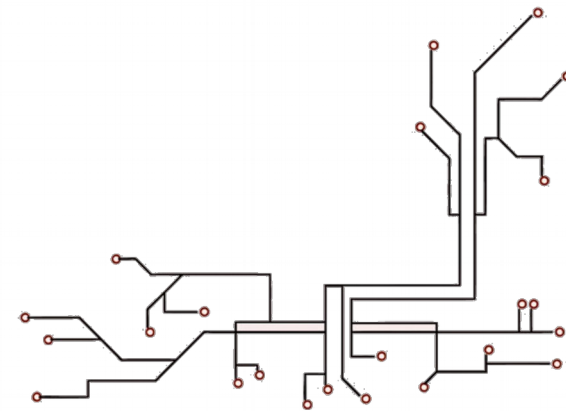



# 2-Wheel Differential Drive

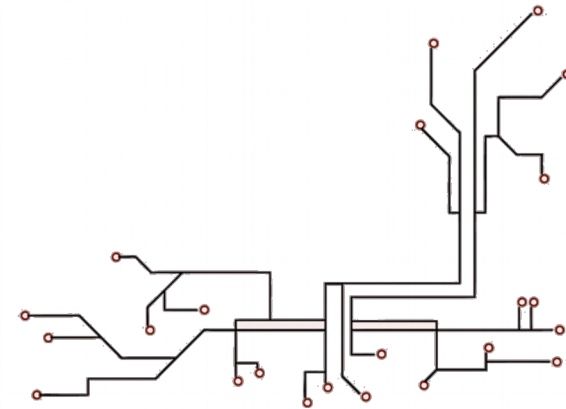
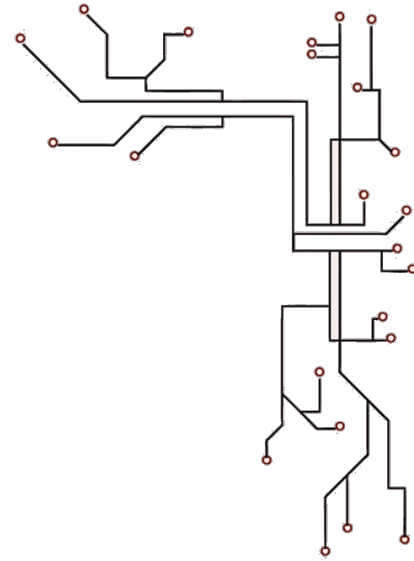
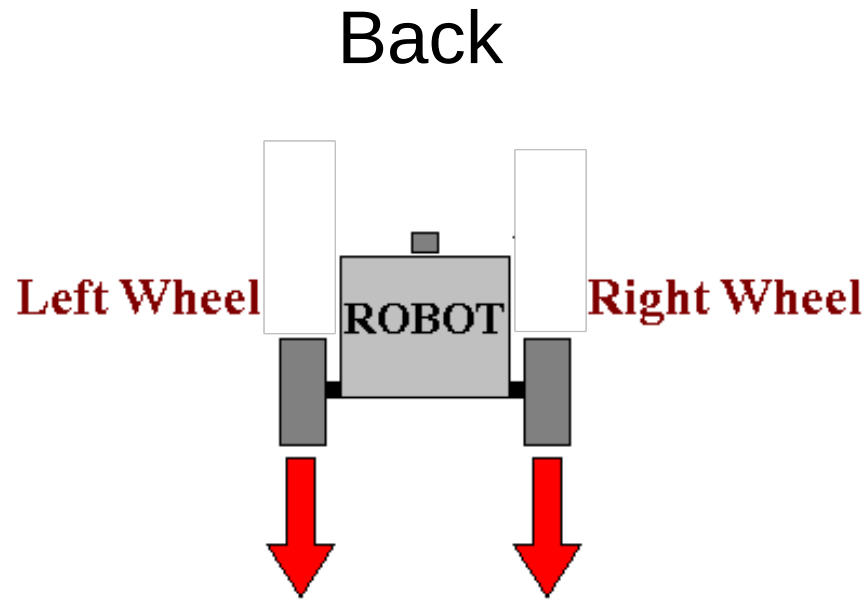

# 2-Wheel Differential Drive

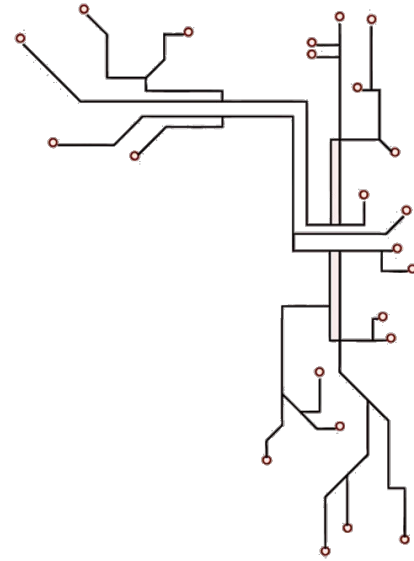
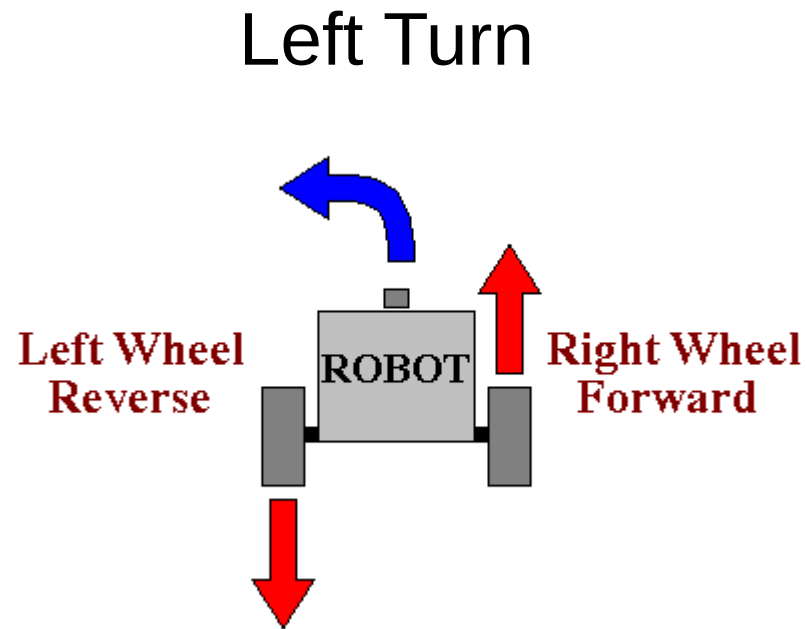

**A POSTERIORI**

Play · Experience · Learn

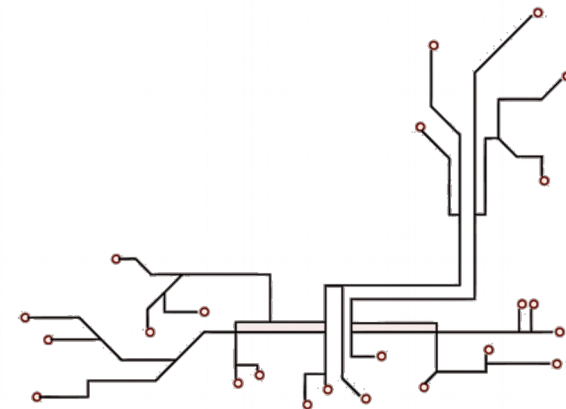

# 2-Wheel Differential Drive

Right Turn

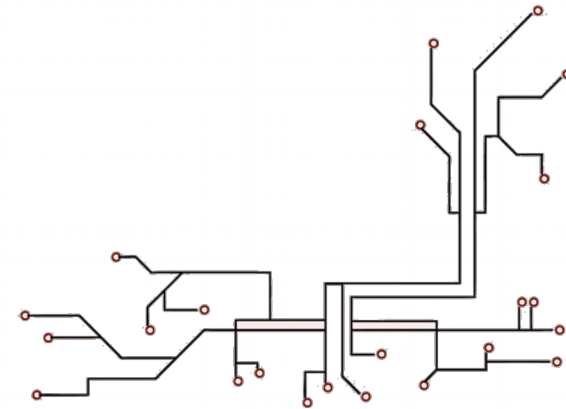
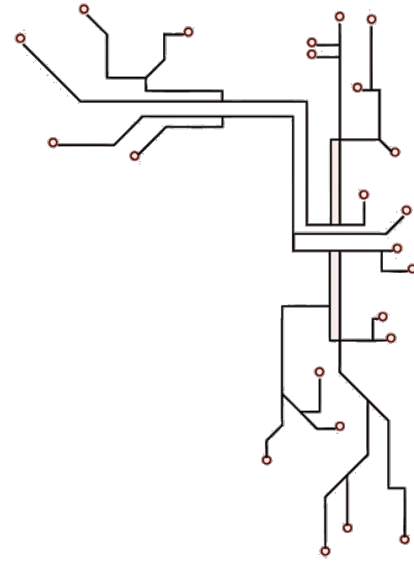
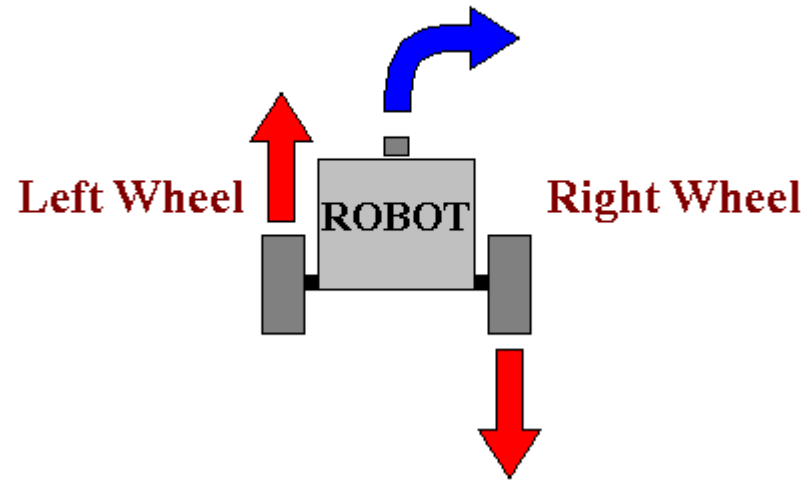

# EV3 Robot Educator

Let's Build!!!

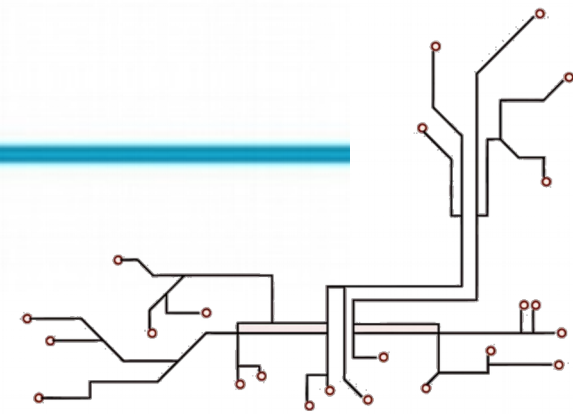
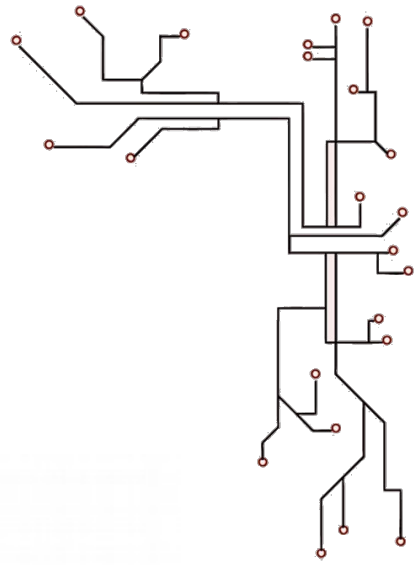
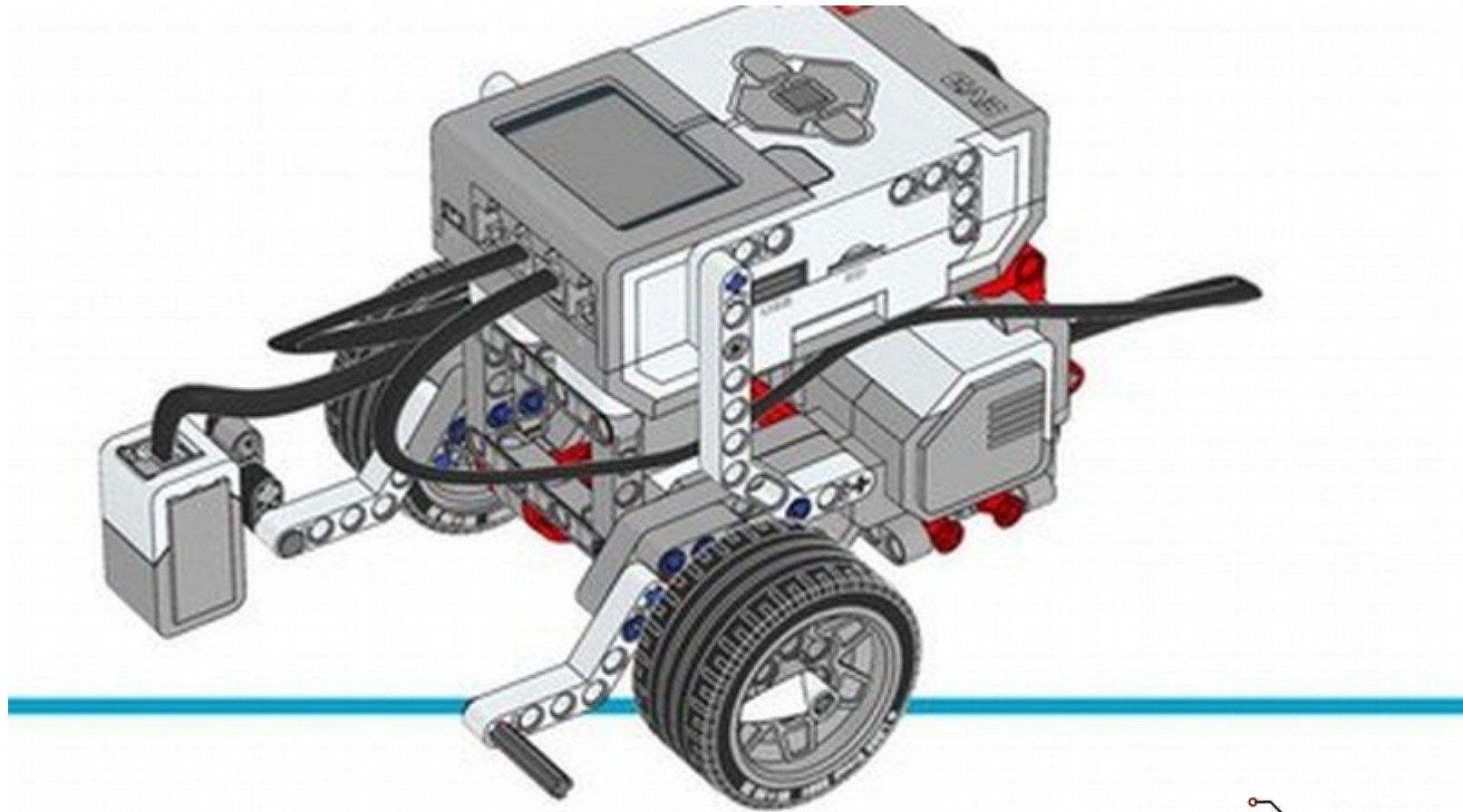

**A POSTERIORI**

Play · Experience · Learn

# EV3 Robot Educator

Then Program...

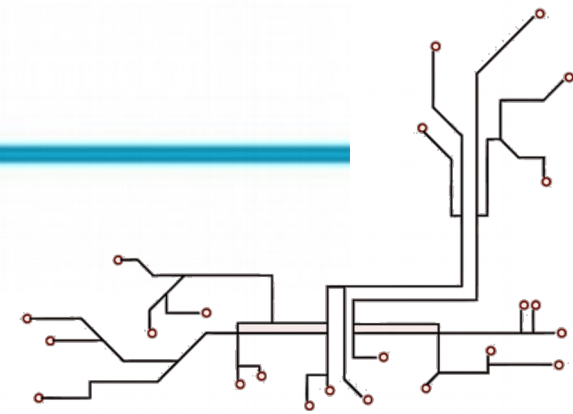
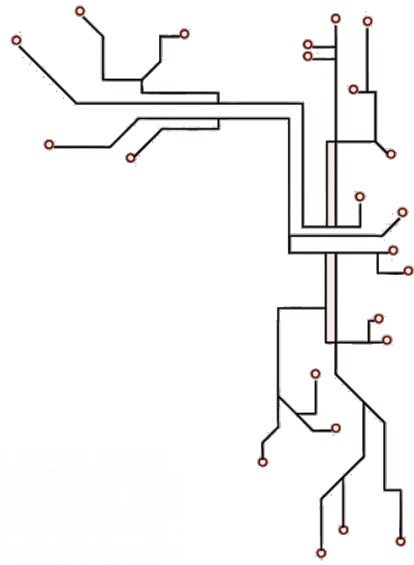
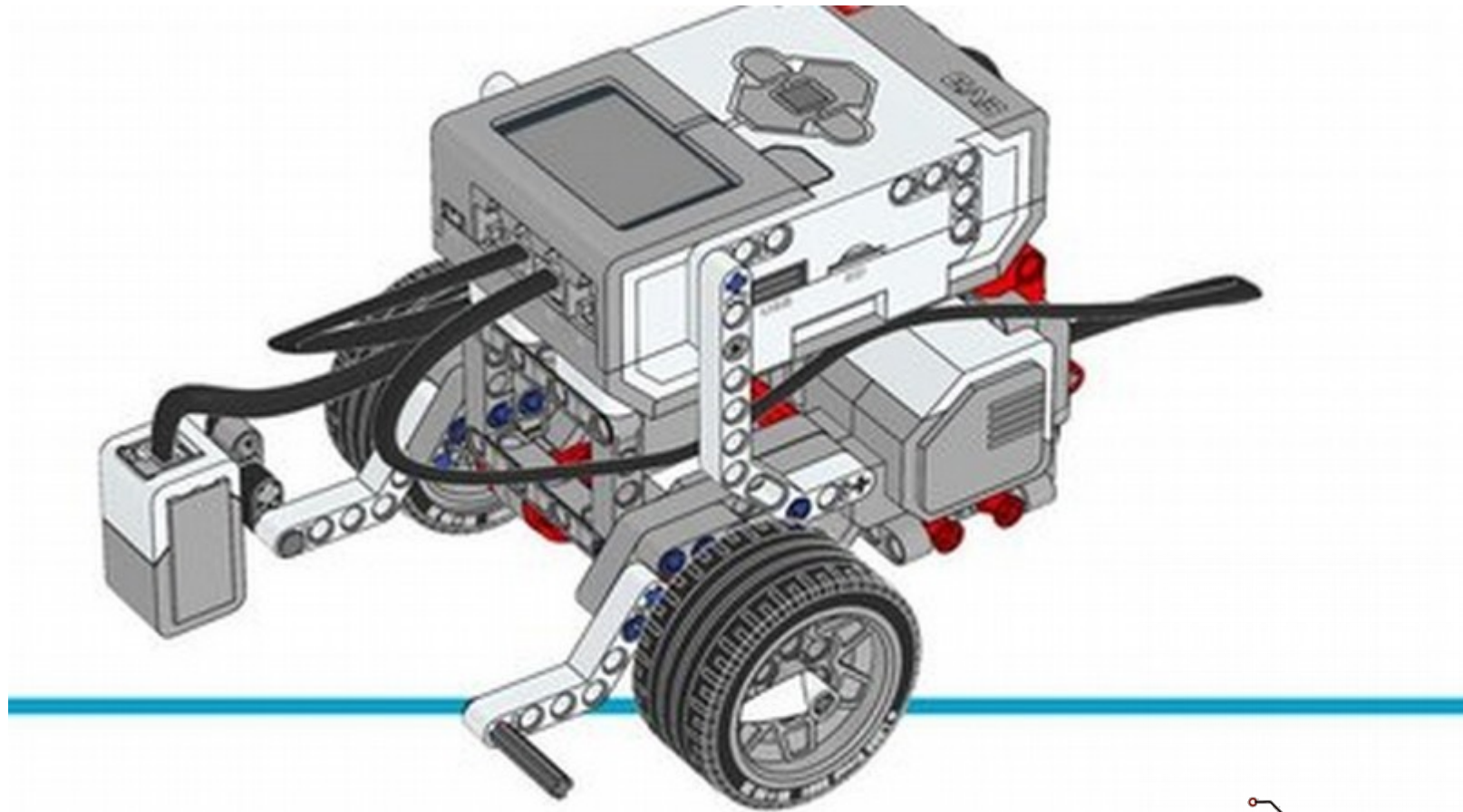

**A POSTERIORI**

Play · Experience · Learn